

MT100

MOUNTCORDER

USER'S MANUAL

MANUAL NO. MT100-UM-151

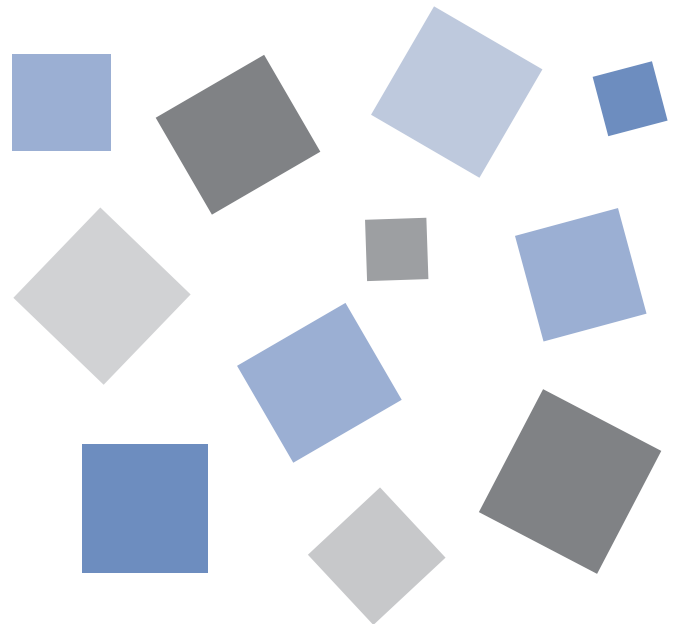

GRAPHTEC

Introduction

Thank you for purchasing the MOUNTCORDER MT100.
Please read this manual thoroughly before attempting to use your new product to ensure that you use it correctly and to its full potential.

Notes on Use

Be sure to read all of the following notes before attempting to use the MT100 MOUNTCORDER.

1. Note on the CE Marking

The MT100 complies with the EN61326 Class A standard based on the EMC directive (89/336/EMC). It also conforms to the EN61010-1 standard based on the LV directive (72/73/EEC).

Although the MT100 complies with the above-mentioned standards, be sure to use it correctly in accordance with the instructions and notes provided in its User's Manual.

Moreover, use of the MT100 by incorrect procedures may result in damage to the MT100 or may invalidate its safeguards. Please confirm all of its notes regarding use and other related information to ensure correct use.

2. Warning

This is a Class A product according to the EMC directive.

In a domestic environment, this product may cause radio interference or may be affected by radio interference to the extent that proper measurement cannot be performed.

3. Notes for Safe Operation

- (1) In environments where there is a lot of noise or where the power supply is unstable, we recommend that you ground the MT100.
- (2) When a high-voltage signal cable has been connected to the main unit's analog signal input terminal, avoid touching the leads of the input terminal's signal cable to prevent electrical shock due to high voltage.
- (3) Ensure that the MT100's power source is positioned so that it can easily be disconnected.

4. Notes on Functions and Performance

- (1) Be sure to connect the main unit to an AC power supply that conforms to the rated range. Connection to a non-rated power supply may cause the main unit to overheat and break down.
- (2) Do not block the vent on the main unit. Continued operation with the vent blocked may cause the main unit to overheat and break down.
- (3) To avoid malfunctions and other damage, avoid using the MT100 in the following locations.
 - Places exposed to high temperature and/or high humidity, such as in direct sunlight or near heating equipment. (Operating range - Temperature: 0 to 50°C, Humidity: 5 to 85% RH)
 - Locations subject to excessive salt spray or heavy fumes from corrosive gas or solvents.
 - Excessively dusty locations.
 - Locations subject to strong vibrations or shock.
 - Locations subject to surge voltages and/or electromagnetic interference.
- (4) If the main unit becomes soiled, wipe it off using a soft, dry cloth. Use of organic solvents (such as thinner or benzene) causes deterioration and discoloration of the outer casing.

Introduction

- (5) Do not use the MT100 in the vicinity of other devices which are susceptible to electromagnetic interference.
- (6) Measured results may not conform to the stated specifications if the MT100 is used in an environment which is subject to strong electromagnetic interference.
- (7) Insofar as possible, position the MT100 input signal cables away from any other cables which are likely to be affected by electromagnetic interference.
- (8) For stabilized measurement, allow the MT100 to warm up for at least 30 minutes after turning it on.

To Ensure Safe and Correct Use

- To ensure safe and correct use of the MT100, read this Manual thoroughly before use.
- After having read this Manual, keep it in a handy location for quick reference as needed.
- Do not permit small children to touch the MT100.
- The following describes important points for safe operation. Please be sure to observe them strictly.

Conventions Used in This Manual

To promote safe and accurate use of the MT100 as well as to prevent human injury and property damage, safety precautions provided in this manual are ranked into the five categories described below. Be sure you understand the difference between each of the categories.



DANGER

This category provides information that, if ignored, is highly likely to cause fatal or serious injury to the operator.



WARNING

This category provides information that, if ignored, is likely to cause fatal or serious injury to the operator.



CAUTION

This category provides information that, if ignored, could cause physical damage to the MT100.



HIGH TEMPERATURE

This category provides information that, if ignored, is likely to cause burns or other injury to the operator due to contact with high temperature.





ELECTRICAL SHOCK



This category provides information that, if ignored, is likely to expose the operator to electrical shock.

Description of Safety Symbols





The  symbol indicates information that requires careful attention (which includes warnings). The point requiring attention is described by an illustration or text within or next to the  symbol.



The  symbol indicates action that is prohibited. Such prohibited action is described by an illustration or text within or next to the  symbol.



The  symbol indicates action that must be performed. Such imperative action is described by an illustration or text within or next to the  symbol.

Safety Precautions

WARNING

Be sure to securely connect the MT100's power cord.

- After checking that the Power switch is turned off, connect the power cord's female plug to the MT100 and then connect its male plug into the electrical socket.
- Use of the MT100 without the power cord securely plugged into the electrical socket may result in electrical shock due to current leakage.



Securely connect the power cord
Make sure that the socket has a good
protective ground

If the MT100 generates smoke, is too hot, emits a strange odor, or otherwise functions abnormally, turn off the Power switch and power source, and disconnect the power cable.

- Use of the MT100 in such status may result in a fire hazard or electrical shock.
- After checking that smoke is no longer being generated, contact your sales representative or nearest Graphtec vendor to request repair.
- Never try to perform repair yourself. Repair work by inexperienced personnel is extremely dangerous.



Amateur repair
prohibited

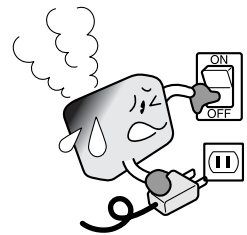

Before turning on the MT100, ensure that the electric socket's supply voltage conforms to the MT100's power rating.

- Use of a different supply voltage may cause damage to the MT100 or a fire hazard due to electrical shock or current leakage.



Use of a different
supply voltage
prohibited

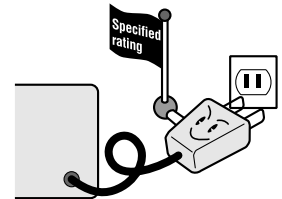

Never disassemble or remodel the MT100.

- Such action may cause a fire hazard due to electric shock or current leakage.
- Contact with a high-voltage component inside the MT100 may cause electric shock.
- If repair is required, contact your sales representative or nearest Graphtec vendor.



No disassembly



Avoid using the MT100 in extremely dusty or humid places.

- Such use may cause a fire hazard due to electrical shock or current leakage.



Use prohibited



Watch out for
electrical shock



Safety Precautions

WARNING

Avoid using the MT100 in places where it may be exposed to water such as bathrooms, locations exposed to wind and rain, and so on.



Avoid water



Watch out for electrical shock

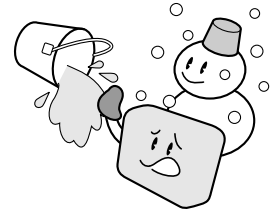

Prevent dust or metallic matter from adhering to the power supply connector and power terminal.

- Adhesion of foreign matter may cause a fire hazard due to electrical shock or current leakage.



No foreign matter



Watch out for electrical shock

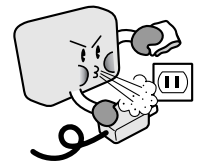

Never use a damaged power cord.

- Use of a damaged cord may result in a fire hazard due to electrical shock.
- If the cord becomes damaged, order a new one to replace it.



Unplug the power cord from the socket

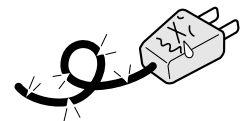

Safety Precautions

CAUTION

Do not use or store the MT100 in a location exposed to direct sunlight or the direct draft of an air conditioner or heater.

- Such location may impair the MT100's performance.

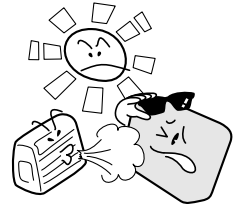

Do not place coffee cups or other receptacles containing fluid on the MT100.

- Fluid spilling inside the MT100 may cause a fire hazard due to electrical shock or current leakage.



Avoid fluids



Watch out for electrical shock



Do not use the MT100 in a location subject to excessive mechanical vibration or electrical noise.

- Such location may impair the MT100's performance.



Use prohibited

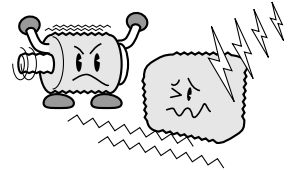

To insert or disconnect the power cord or a signal input cable, grasp the power cord's plug or the signal input cable's connector.

- Pulling the cord/cable itself damages the cord/cable, resulting in a fire hazard or electrical shock.



No pulling

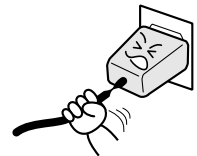

If fluid or foreign matters enters inside the MT100, turn off the Power switch and power source, and disconnect the power cable.

- Use in such status may cause a fire hazard due to electrical shock or current leakage.
- Contact your sales representative or nearest Graphtec vendor to request repair.



Unplug the power cord from the socket

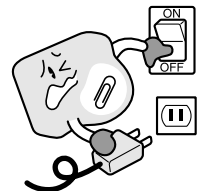

Do not input voltage that exceeds the permissible input voltage range that is specified on the MT100's label.

- Exceeding the specified voltage input range may cause electrical shock or a fire hazard.



Use prohibited

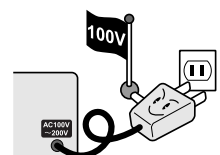

Safety Precautions

CAUTION

Do not attempt to lubricate the MT100's mechanisms.

- Such action may cause the MT100 to break down.



No lubrication

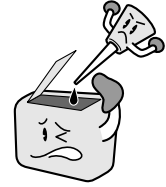

Never clean the MT100 using a volatile solvent (such as thinner or benzene).

- Such action may impair the MT100's performance.
- Clean off any soiled areas using a soft dry cloth.



No volatile solvents

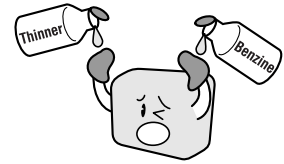

CONTENTS

Introduction	i
To Ensure Safe and Correct Use	iii
Conventions Used in This Manual	iii
Description of Safety Symbols	iii
Safety Precautions	iv
General Description	1-1
1.1 Overview	1-2
1.2 Features	1-2
Input/Output	1-2
Display & Operation	1-2
Data Capture	1-2
Data Control & Processing	1-3
Operating Environment	1-3
1.3 Operating Environment	1-4
Ambient Operating Conditions	1-4
Warming-up Before Use	1-4
Configuration When in Use	1-4
1.4 Notes on Temperature Measurement	1-5
1.5 Notes on Using the Monitor	1-5
1.6 Changing the Display Language	1-6
1.7 Notes on Installation category (over-voltage category)	1-6
Checks and Preparation	2-1
2.1 Checking the Outer Casing	2-2
2.2 Checking the Accessories	2-2
2.3 MT100 Part Names and Functions	2-3
Opening the Control Panel Cover	2-3
Closing the Control Panel Cover	2-3
Opening the Front Panel	2-4
2.4 Installing and Connecting MT100	2-5
Installation Site	2-5
Installation Procedure	2-5
2.5 Connecting the Power Cable and Turning on the Power	2-7
Connecting Cables	2-7
2.6 Connecting the Signal Input Cables	2-9
Caution on Connecting Cables	2-9
Connecting Cables	2-9
Connection Diagram	2-10
Internal Equivalent Circuit of the Analog Input Circuit	2-10
2.7 Mounting and Removing Input Terminals	2-11
Removing Input Terminals	2-11
2.8 Logic Alarm Cable Connection and Functions	2-12
Caution on Connecting Cables	2-12
Connecting Cables	2-12
Internal Equivalent Circuit of the Input/Output Circuit	2-13

- 2.9 Attaching USB Memory 2-15**
 - Inserting a USB Memory 2-15
 - Supported USB Memory Dimensions 2-15
- 2.10 Connecting to a PC 2-16**
 - Connection Using a USB Cable 2-16
 - LAN Connection 2-17
- 2.11 Connecting the Humidity Sensor 2-18**
- 2.12 Attaching the Desktop Case (B-541) 2-19**
 - Case Set Contents 2-19
 - To Attach 2-19
- 2.13 Precautions to Observe When Performing Measurement 2-20**
- 2.14 Noise Countermeasures 2-21**
- 2.15 Setting the Date and Time 2-22**
 - How to Recharge the Rechargeable Battery 2-22
 - How to Set the Date and Time 2-22

Settings and Measurement 1

- 3.1 Window names and functions 2**
 - Windows 2
 - Status Section 3
 - Measured Data Section 4
- 3.2 Key Operation 6**
 - (1) CURSOR (ALM CLR) 6
 - (2) SPAN/TRACE/POSITION† 7
 - (3) QUIT (LOCAL) 7
 - (4) Direction keys 8
 - (5) MENU 8
 - (6) START/STOP (USB DRIVE) 9
 - (7) ENTER 9
 - (8) DISPLAY 10
 - (9) TIME/DIV 11
 - (10) REVIEW 11
- 3.3 Operation Modes 12**
 - (1) Free Running 12
 - (2) Capturing 13
 - (3) Dual View Replaying 13
 - (4) Replaying 14
- 3.4 Setting Menus 15**
- 3.5 Key Lock Function 45**
- 3.6 Exchanging USB Memory Device During Capture 47**
- 3.7 WEB Server Function 49**
- 3.8 Setting Examples 53**

Specifications 5-1

- 4.1 Standard Specifications 5-2**
 - Standard Specifications 5-2
 - Internal Memory Devices 5-2
 - PC Interface 5-2
 - Monitor 5-2

4.2	Function Specifications	5-3
	Function Specifications	5-3
	Trigger Functions	5-3
	External Input/Output Functions	5-4
	Control Software	5-4
	Input Unit Specifications	5-5
4.3	Accessory/Option Specifications	5-6
	Accessories	5-6
	Desktop Case B-541 (Option)	5-6
	Humidity Sensor B-530 (Option)	5-6
	Options	5-6
4.4	External Dimensions	5-7
4.5	Panel Cut-out Dimensions (Mounting Single Device)	5-8
4.6	Panel Cut-out Dimensions (Mounting Multiple Devices)	5-9

CHAPTER 1

General Description

This chapter provides a general description of the MT100 and its features.

- 1.1 Overview**
- 1.2 Features**
- 1.3 Operating Environment**
- 1.4 Notes on Temperature Measurement**
- 1.5 Notes on Using the Monitor**
- 1.6 Changing the Display Language**
- 1.7 Notes on Installation category
(over-voltage category)**

1.1 Overview

The MT100 (with color monitor and internal memory) are compact, lightweight, multi-channel paperless recorders.

MT100 are also equipped with an internal flash memory to store data and enable the direct capture of a large volume of data to USB memory.

Furthermore, the MT100 are equipped with USB and Ethernet interfaces to a PC to enable system configurations according to your application.

The Ethernet feature includes WEB and FTP server functions which allow monitoring from a remote location and data transfer.

1.2 Features

Input/Output

- (1) Adoption of M4 screw type input terminals facilitates wiring.
- (2) All channels are isolated, enabling measurement of signals of different references.
- (3) Relay contact output is provided as a standard feature, enabling easy application as alarm output.

Display & Operation

- (1) With the MT100's 5.7-inch TFT color liquid crystal display, you can confirm the waveforms of measured data and each channel's settings at a glance.
- (2) Easy operation is achieved through a straightforward menu structure and key allocation which resembles mobile phones.
- (3) Waveforms are displayed in a format similar to those of recording papers in analog-type recorders, allowing quick reference of previous states.

Data Capture

- (1) Data can be directly captured and maintained in the internal or USB memory.
- (2) Internal memory used for the built-in memory maintains captured data even after the power is turned off.
- (3) The Internal memory can be used with disk images thus multiple data items can be maintained.
- (4) The MT100 is equipped with resume feature that may be used in case of power discontinuity. If power is cut off during the capturing of data and then later resumed, this feature will start recapturing under the same conditions used before the power was cut off.
- (5) USB memory can be replaced without terminating the data capture operations. This allows any part of the data to be extracted during long capture operations.

Data Control & Processing

- (1) The application software provided lets you set conditions and monitor data on a PC.
- (2) The USB drive mode function enables the MT100's internal memory to be recognized as an external drive by your PC. (Connect the MT100 to your PC and turn on the power supply to the MT100 while holding down the [START] key.)
- (3) Captured data can be read from the application software to files and displayed for processing.
- (4) Data can be transferred off-line to a computer using USB memory.
- (5) The WEB server function enables control and monitoring from a remote location without using dedicated software.
- (6) The FTP server function enables handling internal memory and USB memory data from a PC.
- (7) Measurement data can be backed up to an FTP server using the FTP client function.
- (8) Time information can be adjusted through the NTP client function.

Operating Environment

- (1) The front panel is dust/water resistant (IP65 compatible) to withstand harsh measurement environments.

1.3 Operating Environment

This section explains the operating environment for the MT100.

Ambient Operating Conditions

- (1) Ambient temperature and humidity (the MT100 must be operated within the following ranges.)
 - Temperature range: 0 to 50°C
 - Humidity range: 5 to 85% RH
- (2) Environment (do not use in the following locations.)
 - A Location such as being exposed to direct sunlight
 - Locations exposed to salty air, corrosive gases, or organic solvents
 - Dusty locations
 - Locations subject to vibration or impact
 - Locations subject to voltage surge or electromagnetic interference such as lightning or electric furnaces
- (3) Installation category (over-voltage category)
 - The MT100 conforms to the IEC664 installation category 1



If condensation occurs...

Condensation occurs in the form of water droplets on the device surfaces and interior when the MT100 is moved from a cold to a warm location. Using the MT100 with condensation will cause malfunctioning. Wait until the condensation has disappeared before turning on the power.

Warming-up Before Use

The MT100 should be allowed to warm up with the power turned on for approximately 30 minutes to ensure that it operates according to the specified performance.

Configuration When in Use

Do not use the MT100 standing upright or at an angle. It must always be laid flat.

Usage Configuration

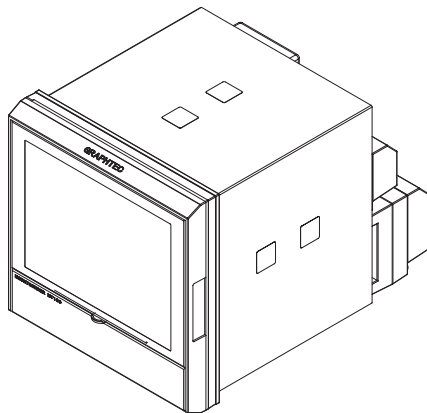

CAUTION

Do not block the air vent on the MT100, as this will cause malfunctioning. Measurement accuracy may not be satisfactory if the system is used in a condition other than described above.

1.4 Notes on Temperature Measurement

Please observe the following precautions when performing temperature measurement.

- (1) Make sure the terminal covers are always attached.
- (2) Do not use wires with large diameters that have a high heat dissipation effect (0.65ϕ or smaller is recommended).
- (3) Do not block the air vents. Always provide a space of at least 30 cm on all sides of the MT100.
- (4) For stabilized temperature measurement, allow the MT100 to warm up for at least 30 minutes after turning it on.
- (5) Exposure of the input terminals to direct drafts, direct sunlight, or abrupt changes in temperature may impair the equilibrium of the input parts and result in measurement errors. To measure temperature in such an environment, take appropriate countermeasures such as changing the installation site of the MT100.
- (6) To conduct measurement in noisy environments, connect the MT100's GND terminal to ground (refer to page 2-21).
- (7) If measured values fluctuate due to noise, set to a slower sampling speed (refer to page 3-22).

1.5 Notes on Using the Monitor

The monitor is an LCD display unit, and so the display will vary depending on the operating environment.

CHECKPOINT

If the screen saver function is used, it will operate and clear the screen if no operations are performed during the preset time. If the screen saver operates, press any key to restore the display.

CAUTION

- Condensation may form on the LCD screen if the MT100 is moved from a cold to a warm location. If this occurs, wait until the LCD screen warms up to room temperature.
 - The LCD screen is manufactured to extremely high precision. Black dots may appear, or red, blue, and green dots may not disappear. Likewise, streaks may appear when viewed from certain angles. These phenomena are due to the LCD screen construction, and are not signs of a fault.
-

1.6 Changing the Display Language

The language selection menu will be displayed when this device is powered ON for the first time. Set the display language as required.

Language settings can be changed at any point.

You can change the display language under Language setting in OTHR menu.



1.7 Notes on Installation category (over-voltage category)

This equipment is suitable for use only within measurement category I,

WARNING

Do not use the equipment for measurements within measurement categories II, III and IV.

This equipment is designed for input voltages up to 50 VDC, do not connect input voltages that might exceed this maximum input voltage. If the input voltage should exceed 60 VDC for a prolonged period it may result in risk of injury to the operator and damage to the equipment.

CHAPTER 2

Checks and Preparation

This chapter explains how to check the MT100's external casing and accessories, and how to prepare the MT100 for operation.

- 2.1 Checking the Outer Casing**
- 2.2 Checking the Accessories**
- 2.3 MT100 Part Names and Functions**
- 2.4 Installing and Connecting MT100**
- 2.5 Connecting the Power Cable and Turning on the Power**
- 2.6 Connecting the Signal Input Cables**
- 2.7 Mounting and Removing Input Terminals**
- 2.8 Logic Alarm Cable Connection and Functions**
- 2.9 Attaching USB Memory**
- 2.10 Connecting to a PC**
- 2.11 Connecting the Humidity Sensor**
- 2.12 Attaching the Desktop Case (B-541)**
- 2.13 Precautions to Observe When Performing Measurement**
- 2.14 Noise Countermeasures**
- 2.15 Setting the Date and Time**

2.1 Checking the Outer Casing

After unpacking, check the MT100's outer casing before use. In particular, please check for the following:

- Surface scratches
- Other flaws such as stains or dirt

2.2 Checking the Accessories

After unpacking, check that the following standard accessories are included.

Standard Accessories

Item	Remarks	Quantity
Quick Start Guide	MT100-UM-85x	1
CD-ROM	User's Manual, Application software	1
Panel mount bracket		2

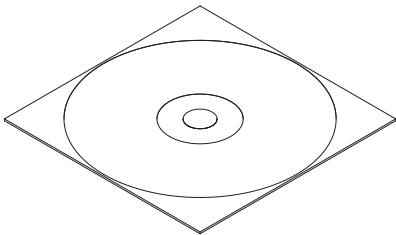

CD-ROM: 1

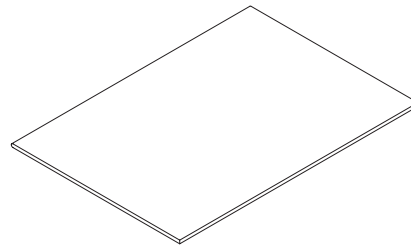

Quick start Guide: 1

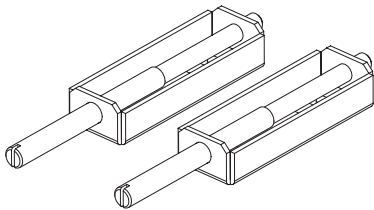

Panel mount bracket: 2

Optional Accessories

Item	Option No.	Remarks
Desktop case	B-541	Desktop case, screws, power cable
Humidity sensor	B-530	3-m length with dedicated power connector
T-type thermocouple	JBS-7115-5M-T	5-m length, 5 thermocouples per set
K-type thermocouple	JBS-7115-5M-K	5-m length, 5 thermocouples per set
K-type thermocouple (needle type probes)	RIC-410	1.1m
K-type thermocouple (stationary surface probes)	RIC-420	1.1m
K-type thermocouple (stationary surface L probes)	RIC-430	1.1m

2.3 MT100 Part Names and Functions

This section describes the names and function of parts of the MT100.

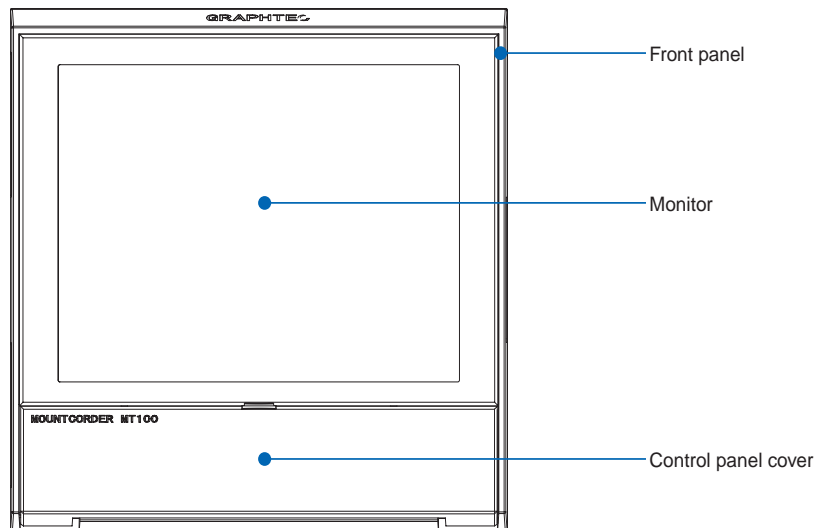

Opening the Control Panel Cover

As shown in the following figure, hold the tab in the center of the control panel cover and pull it in the direction indicated by an arrow to open the cover.

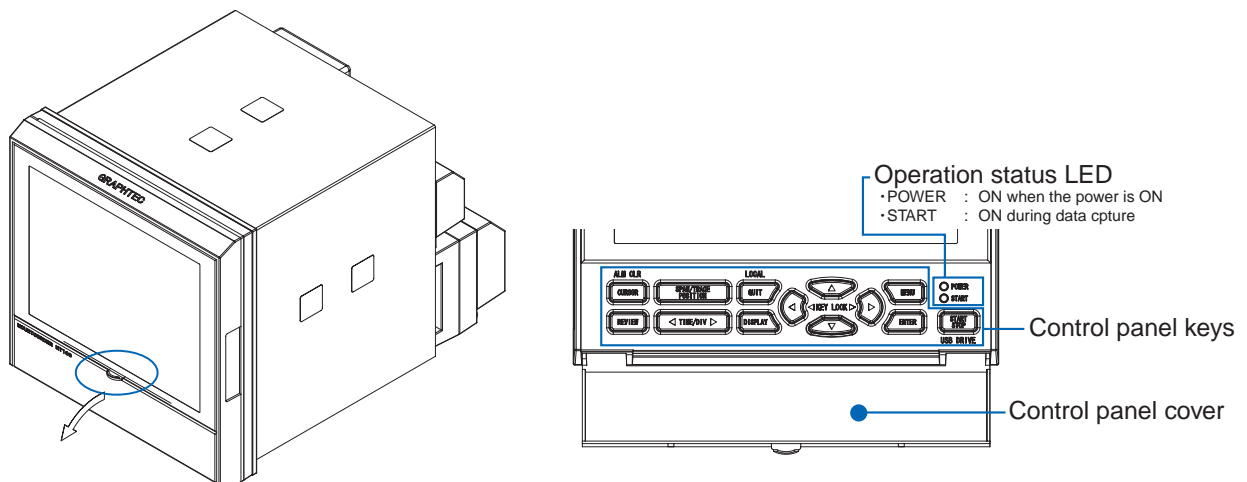

Closing the Control Panel Cover

There are two locks on the cover, indicated by the arrows in the figure below. After you close the cover, lightly press these two locations to make sure the cover is locked.

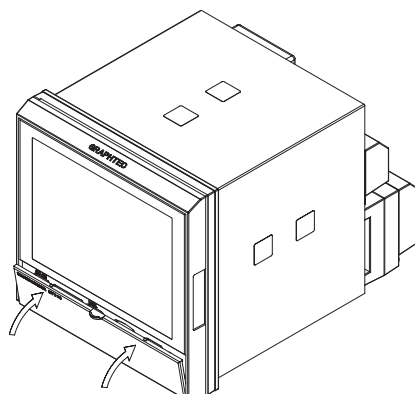

Opening the Front Panel

Pull the part indicated by an arrow in the following figure to open the front panel.

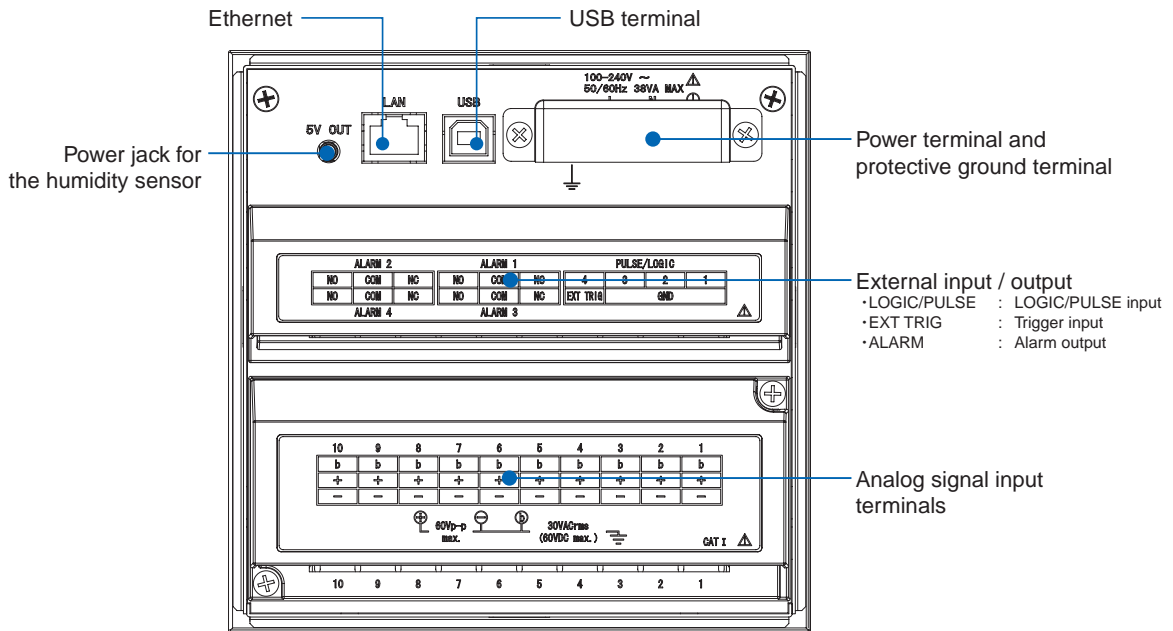
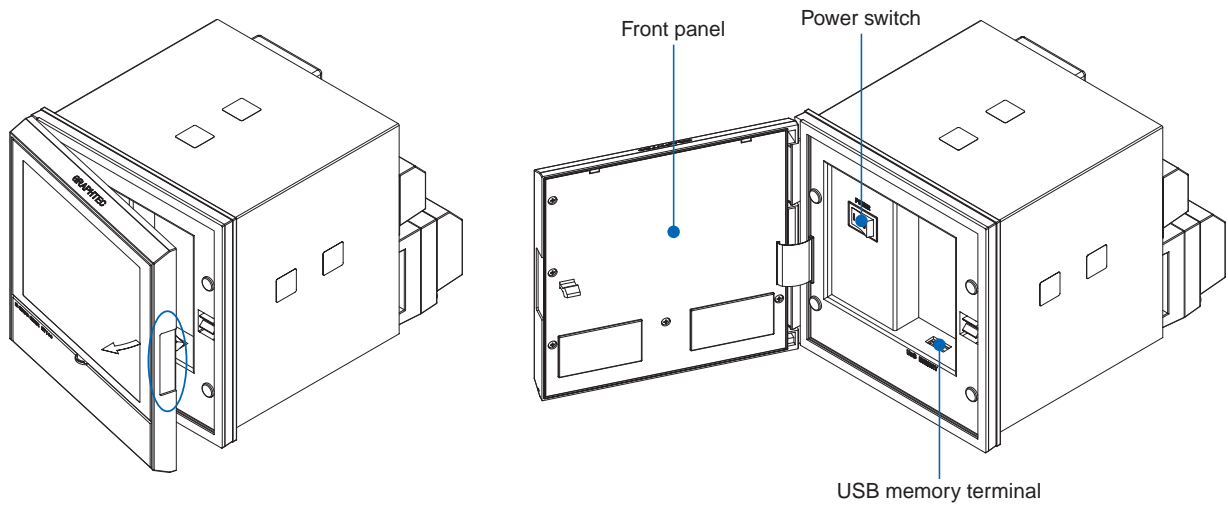

<With desktop case(B-541)>

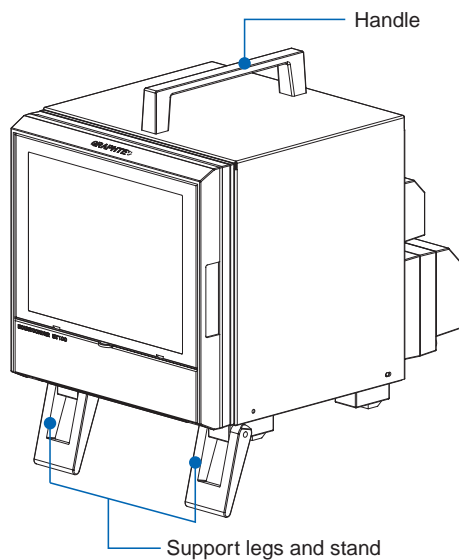

2.4 Installing and Connecting MT100

Installation Site

Install MT100 in an indoor location that meets the following conditions.

- **Instrumentation panel**

MT100 is designed for installation in an instrumentation panel.
Attach the desktop case (B-541) when using the device on a desk.

- **Locations that allow adequate ventilation**

Install the MT100 in a place where adequate ventilation is provided to allow heat dissipation.
To install multiple devices, refer to page 4-9 for panel cut-out dimensions.
Make sure adequate space is provided when installing other devices close to the MT100 by following the specified panel cut-out dimensions.

- **Locations not subject to mechanical vibration**

Install the MT100 in a location not subject to excessive mechanical vibration.

- **Flat surface**

Make sure the MT100 is installed horizontally.
(Mounting the device with a 0 to 30 degree rearward inclination angle is allowed.)

CAUTION

Condensation may occur when the device is moved from a low to high temperature/humidity environment or exposed to a significant temperature change.
Using the MT100 with thermocouple input may cause measurement error.
In such cases, leave the device for at least one hour to warm it up to room temperature before you start any operation.

Do not install the MT100 in the following locations.

- **Outdoors**

- **Locations exposed to direct sunlight or near heating equipment**

Choose an environment that is close to 23 °C and avoid places with significant temperature changes.

- **Locations subject to excessive heavy fumes, steam, humidity, dust, or corrosive gas**

This device may malfunction or be damaged by heavy fumes, steam, humidity, dust, or corrosive gas.
Do not install the MT100 in locations subject to such conditions.

- **Locations subject to electromagnetic interference**

Do not place the MT100 near magnets or instruments that emit electromagnetic radiation.
Using this device close to a strong electromagnetic field may cause measurement error.

Installation Procedure

Use a steel plate (thickness must be within 2 to 26 mm) for the mounting panel.

Use the two brackets supplied with the device to mount the panel.

There are two sets of brackets. These brackets must be attached on two opposite faces: top and bottom OR left and right surfaces.

- (1) Remove the masking tape from the surface where the brackets should be attached.

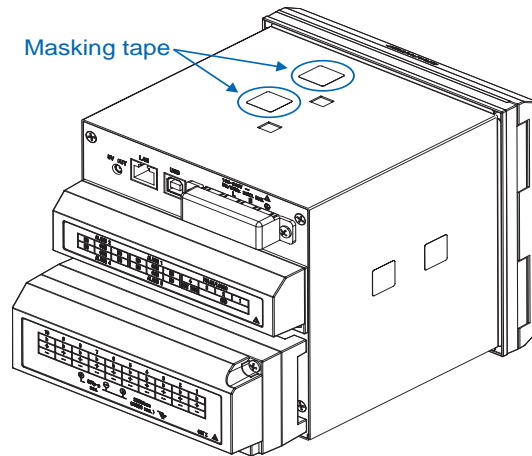

- (2) Insert the device from the front side of the panel.

- (3) Mount the device to the panel using the provided brackets, as shown in the figure below.

- i. Brackets must be attached on two surfaces: top and bottom OR left and right surfaces (make sure you have removed the masking tape that seals the attachment holes on the device).
- ii. Place the brackets on the device and tighten the mounting screws temporarily.

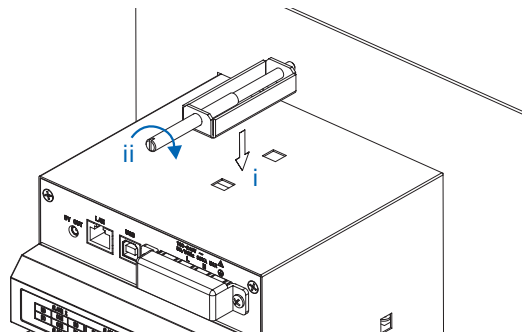

- (4) Tighten screws to the specified torque.

Mount the device by tightening the screws to the specified torque. When the device is close to perpendicular to the panel, make sure the brackets are in full contact with the device case while you tighten the screw.

*Recommended screw torque: 10 to 12 kgf/cm

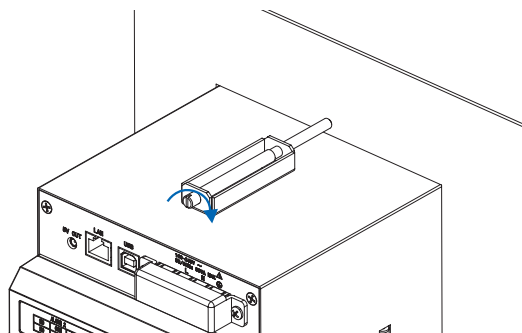

CAUTION

- Tightening screws to a torque exceeding 12 kgf/cm may cause damage to the case and/or brackets.
- Prevent any tools or objects from accidentally falling into the case through the attachment holes.

2.5 Connecting the Power Cable and Turning on the Power

This section describes how to connect the power cable and turn on the power.
No power cord is supplied with the MT100.
Be sure to use a power cord supplied with the desktop case (B-541).

Refer to the warnings below and follow directions when connecting the power cable.
Failure to do so may result in electric shock or damage of the device.

WARNING

- To avoid electric shocks, check that the AC source for the power supply has been turned off.
- To prevent fire, use wires or cables with a performance equivalent to or better than 600V insulated wires (AWG 20 to 16).
- Before turning on the power, be sure to connect the protective ground terminal to the ground at a grounding resistance of 50Ω or less.
- For cables to be connected to a power supply and a protective ground terminal, use non-insulated solderless ring terminals (for 4mm screws) inserted in insulation caps.
- In the power line, provide a switch that can cut off the MT100 from the main power source (double-pole type). As specifications of the switch, the rated steady-state current must be 1A or larger and the rated inrush current must be 60A or larger.
- Do not insert a switch or fuse in a grounding line.
- Use a power supply that meets the following conditions.

Power supply must meet the following conditions.

Item	Specification
Rated power voltage	100 to 240 VAC
Power supply voltage range	90 to 264 VAC
Rated power frequency	50/60Hz
Power frequency tolerance	50/60 Hz $\pm 2\%$
Maximum power consumption	38VA

Connecting Cables

(1) Press the MT100 power switch OFF and open the power terminal (clear) cover.

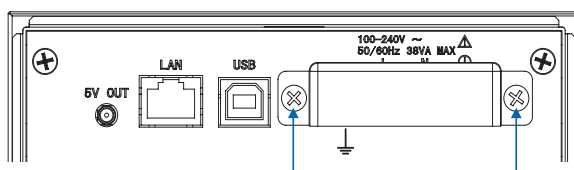

Remove these two screws to remove the power terminal cover

Checks and Preparation

- (2) Connect the Power cable and protective ground cord to the power terminal.
Use non-insulated solderless ring terminals (for 4 mm screw) and insulation caps.
Recommended screw torque is 12 to 14 kgf/cm.

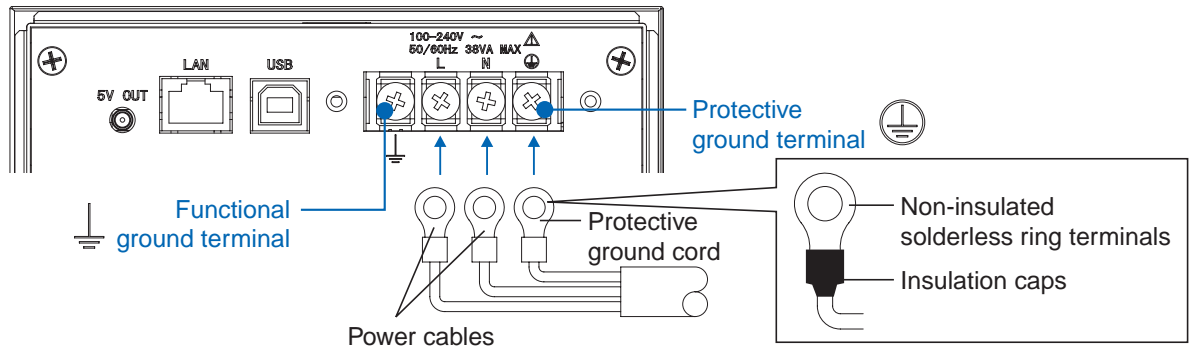

- (3) Close the power terminal (transparent) cover and fix it with screws.
- (4) Open the front panel and turn the power switch ON to power on the device.

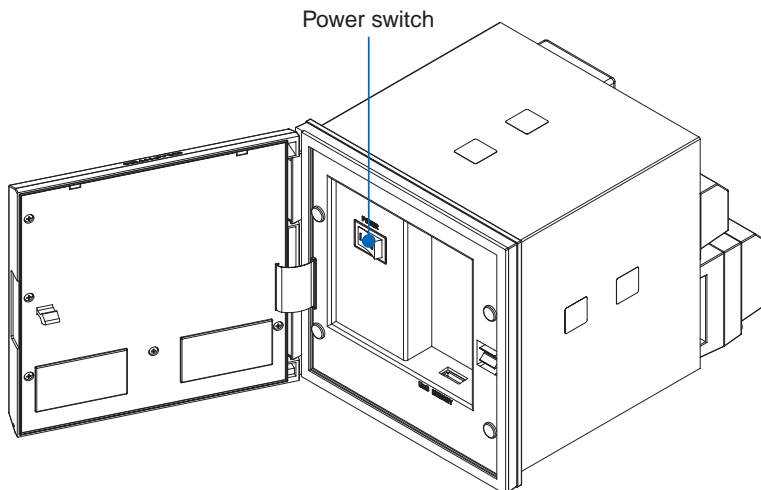

2.6 Connecting the Signal Input Cables

This section describes how to connect the signal input cables.

⚠ WARNING

Make sure the power is OFF while connecting the wires to avoid electric shock.

⚠ CAUTION

- Fix the signal wires to the back of the mounting panel. Pulling the input/output signal wires with strong force may damage terminals and signal wires.
- Use wires that resist rated temperature 70°C or higher to avoid fire hazards.
- Do not apply voltage that exceeds the following to input terminals. Applying high voltage may damage the device.

Maximum input voltage : ± 60 VDC
 Maximum common mode voltage : AC 33 Vrms or ± 60 VDC

Caution on Connecting Cables

Follow the directions below when connecting the input signal cables.

- Use crimp terminals with insulating sleeves (for 4 mm screws) when connecting input signal wire to a terminal.
- Do not place the measurement circuit close to the power line (power circuit) and ground circuit.
- If the measured object is a noise source, refer to page 2-21 and perform the countermeasures.
- Connect the protective ground terminal. Resistance to ground must be 50Ω or less.
- Attach the terminal cover when conducting a temperature measurement using a thermocouple.
- Do not use wires with larger diameters, which have a high heat dissipation effect, when conducting a temperature measurement using a thermocouple (0.65φ or smaller is recommended).
- Avoid environments with significant temperature changes. Turning a fan ON/OFF near the device, for example, may cause a significant temperature change.
- Parallel connection of input wires and other devices may cause measurement values on both devices to fluctuate.
- Do not power ON/OFF neither device during operation. This may cause some effect on the other device.

Connecting Cables

- (1) Remove the terminal cover.
 To remove the cover, pull the cover in direction B while applying force in direction A.

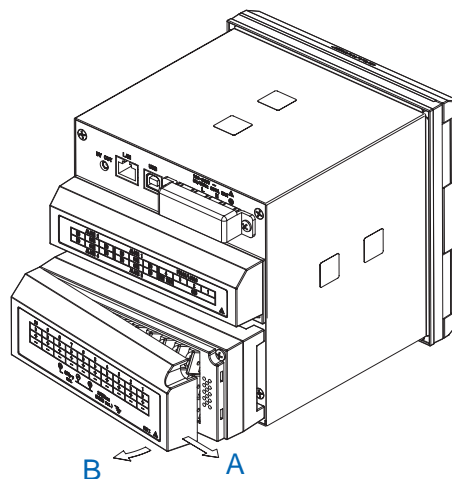

- (2) Connect the signal wire to the input terminal.
 Recommended screw torque is 12 to 14 kgf/cm.
 Refer to the following figure to connect wires to terminals.

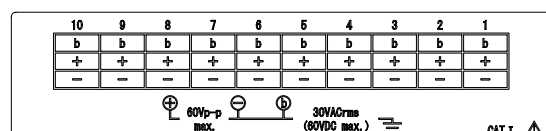
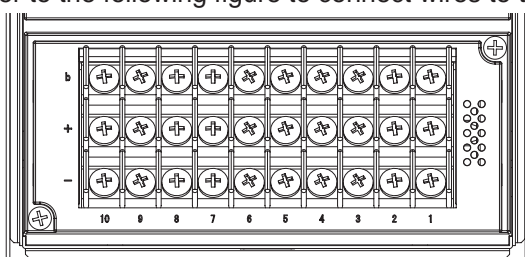

(3) Place the terminal cover back on.

Connection Diagram

voltage input

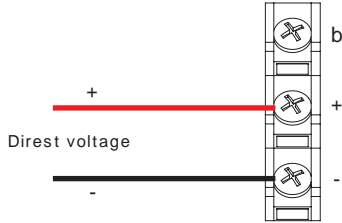

Thermocouple input

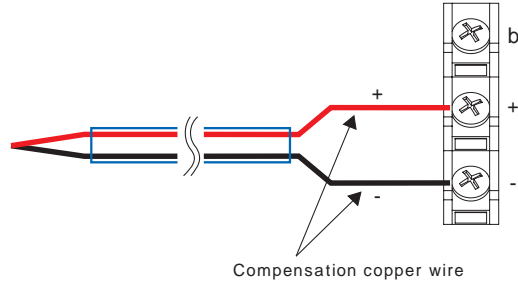

Resistance temperature detector input

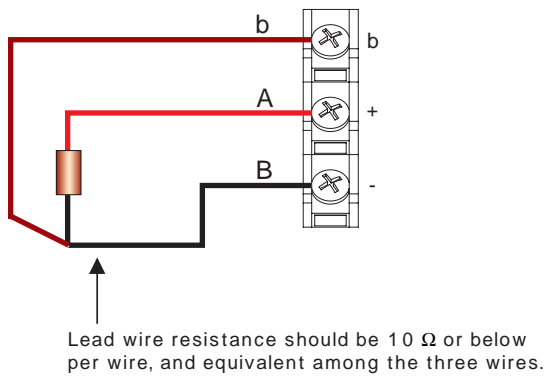

current input

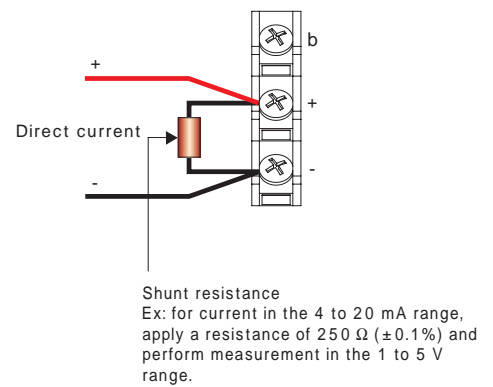

Internal Equivalent Circuit of the Analog Input Circuit

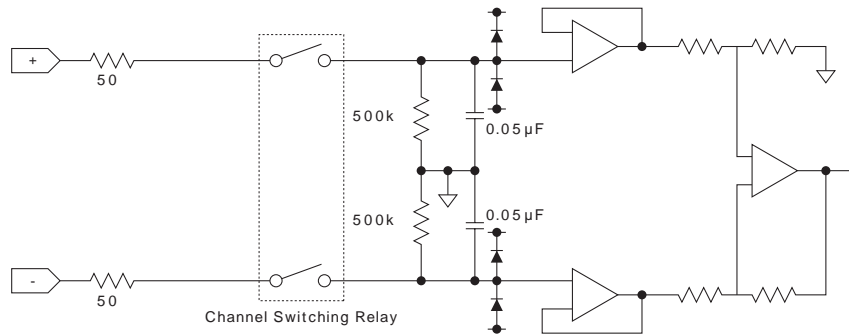

- + High-voltage terminal (terminal for high-voltage input signals)
 - Low-voltage terminal (terminal for low-voltage input signals)
 - b Dedicated terminal when connecting resistance temperature detector
- *Resistance temperature detector input terminals A (+) and B (-) are isolated within each channel. Terminal b is shorted within all channels.

Item	Description
Input configuration	Isolated input, scanning
Analog voltage	20, 50, 100, 200, 500 mV/F.S.; 1, 2, 5, 10, 20, 50 V/F.S.; 1-5V
Thermocouples	K, J, E, T, R, S, B, N, W (WRe 5-26)
Resistance temperature detector	Pt100, JPt100, Pt1000 (IEC751)
A/D resolution	16-bit
Filter	Off, 2, 5, 10, 20, 40 Filter operation is on a moving average basis. The average value of the set sampling count is used.

2.7 Mounting and Removing Input Terminals

Input terminals can be mounted or removed.
Removing the terminals will allow you to easily connect signal wires.

⚠ WARNING

Make sure the signal source is OFF while connecting the wires to avoid electric shock.

⚠ CAUTION

- Make sure the device is powered off when mounting or removing input terminals.
- Make sure the signal source is OFF when mounting or removing input terminals.
- Handle the input terminals with enough care when mounting or removing them.
Do not pull or push terminals with excessive force.

Removing Input Terminals

(1) Remove the two screws, as shown in the figure below.

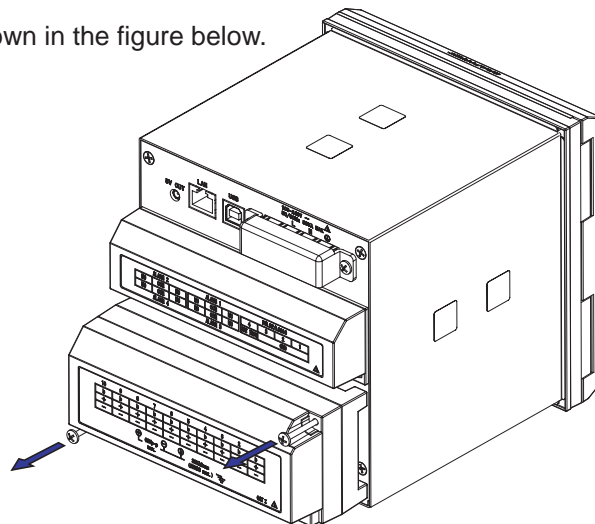

*When you mount the input terminals, tighten the screws to a torque of 6 to 8 kgf/cm.

(2) Pull the input terminals out in the direction indicated by the arrow to remove them.

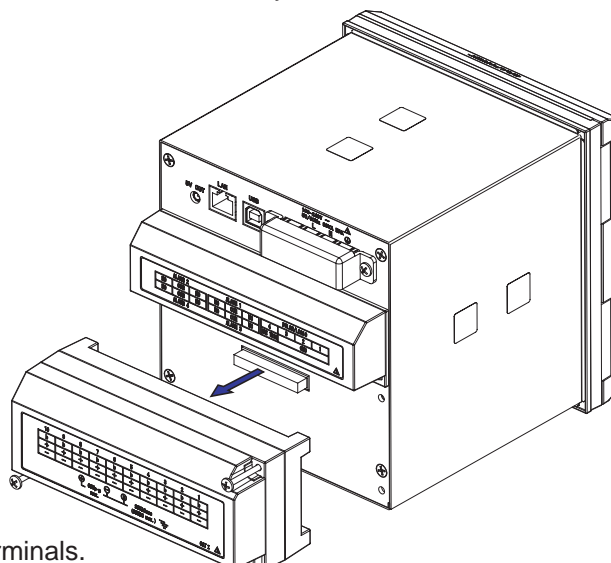

(3) Connect signal wires to the terminals.

(4) Mount the terminals by following the above procedures in reverse order.

2.8 Logic Alarm Cable Connection and Functions

This section describes how to connect the digital input/alarm output terminals.

⚠ WARNING

Make sure the signal source is OFF while connecting the wires to avoid electric shock.

⚠ CAUTION

- Fix the signal wires to the back of the mounting panel. Pulling the input/output signal wires with strong force may damage terminals and signal wires.
- Use wires that resist rated temperature 70°C or higher to avoid fire hazards.
- Do not apply voltage that exceeds the following to input terminals. Applying high voltage may damage the device.

Digital signal terminal : max + 24 VDC

Alarm output relay terminal : 250 VAC/2A, 30 VDC/2A

Caution on Connecting Cables

Follow the directions below when connecting the digital input/alarm output wires.

- Use crimp terminals with insulating sleeves (for 4 mm screws) when connecting signal wire to a terminal.
- Connect the protective ground terminal. Resistance to ground must be 50Ω or less.

Connecting Cables

- (1) Remove the terminal cover.

To remove the cover, pull the cover in direction B while applying force in direction A.

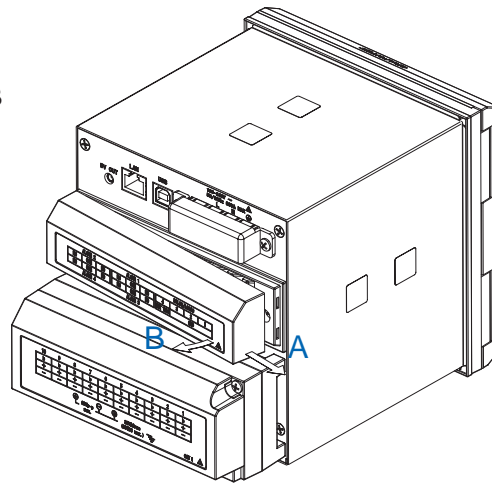

- (2) Connect the signal wire to the input terminal.

Recommended screw torque is 12 to 14 kgf/cm.

Refer to the following figure to connect wires to terminals.

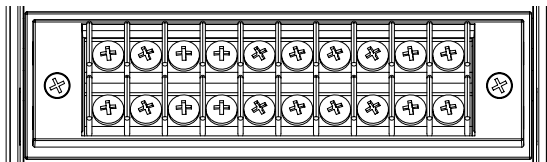

ALARM 2			ALARM 1			PULSE/LOGIC			
NO	COM	NC	NO	COM	NC	4	3	2	1
NO	COM	NC	NO	COM	NC	EXT TRIG	GND		
ALARM 4			ALARM 3						

- (3) Place the terminal cover back on.

Internal Equivalent Circuit of the Input/Output Circuit

Pulse/Logic Input

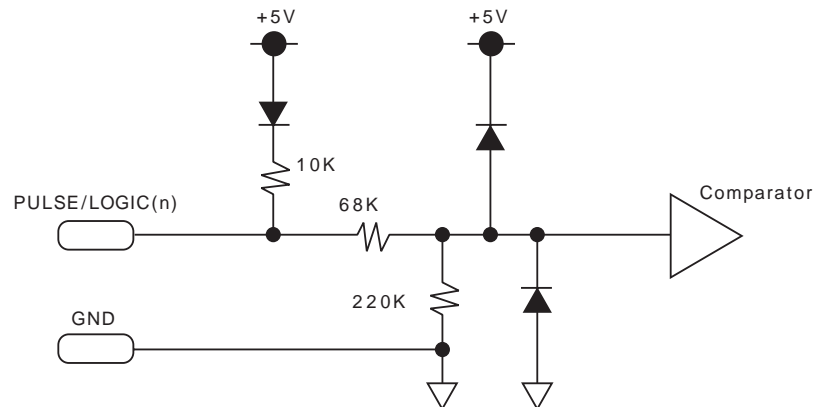

External Trigger Input

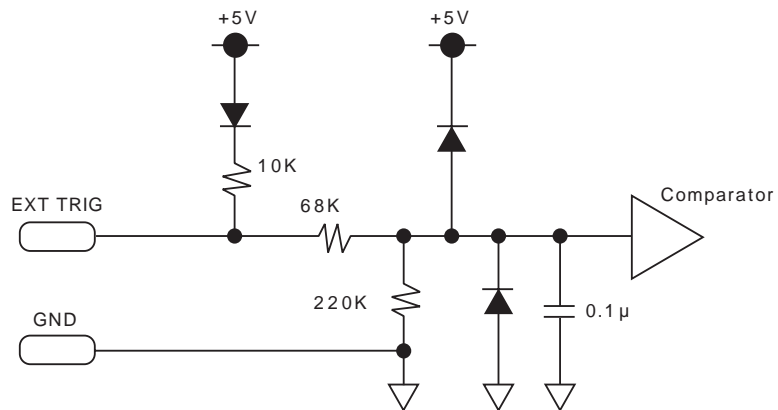

Alarm Output

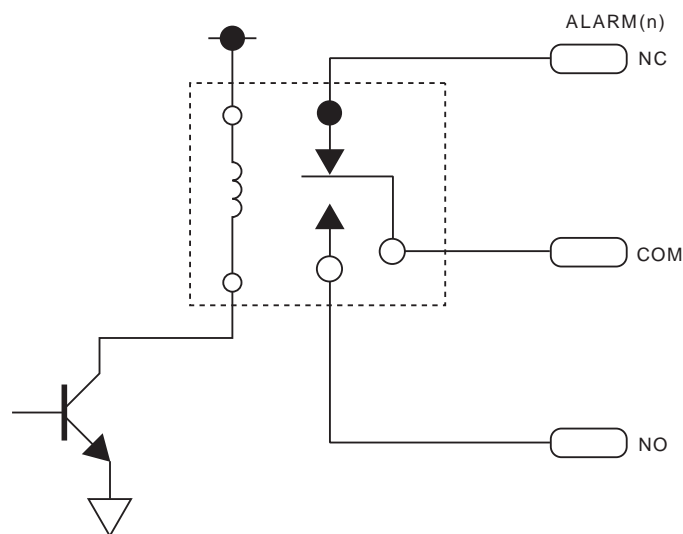

* COM and NO is connected when an alarm is generated (COM and NC will be open).

Logic/Pulse Specifications

Item	Description
Number of input channels	4
Input voltage range	0 to +24V max. (single-ended ground input)
Threshold level	Approx. +2.5V
Hysteresis	Approx. 0.5 V (+2.5 to +3 V)

*Switch between logic and pulse input.

Trigger Input Specifications

Item	Description
Number of input channels	1
Input voltage range	0 to +24V max. (single-ended ground input)
Threshold level	Approx. +2.5V
Hysteresis	Approx. 0.5 V (+2.5 to +3 V)

Alarm Output Specifications

Item	Description
Number of output channels	4 channels
Output format	Relay contact output (NO/NC) <relay ratings> contact rating : 250 VAC/2A, 30 VDC/2A contact relay life : 100,000 operations
Withstand voltage	Between output and GND: 1000 VAC/1 minute

2.9 Attaching USB Memory

Attaching USB memory to the MT100 allows you store measured data directly.

CAUTION

Adequate precautions against static electricity must be taken when handling USB memory.

Inserting a USB Memory

Attach the USB memory to the USB memory terminal.

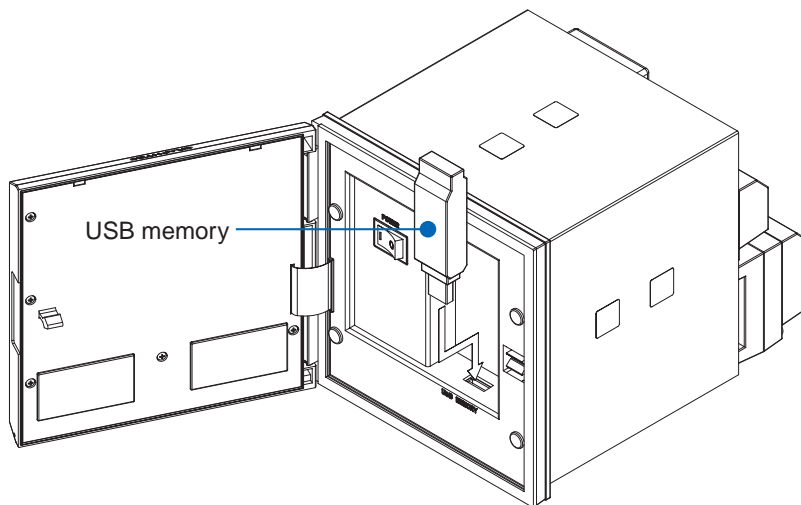

Supported USB Memory Dimensions

The following figure shows the maximum USB memory dimensions supported by this device.

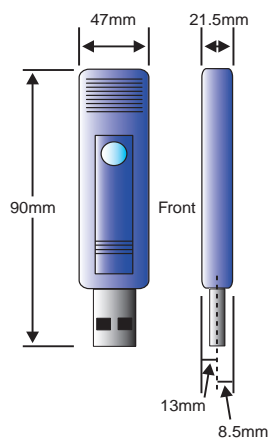

CAUTION

When you attach the USB memory to MT100, be careful during handling so as not to bump or drop the unit.

<Specifications of supported USB memory>

- Power source : +5 V
- Power consumption : 250 mA or below
- Capacity : No limit (except each file must be within 2 GB)

* USB memory with security functions such as fingerprint authentication cannot be used.

2.10 Connecting to a PC

Use the USB, LAN Interface to connect the MT100 to a PC.

Connection Using a USB Cable

Use the USB cable to connect the MT100 to a PC.

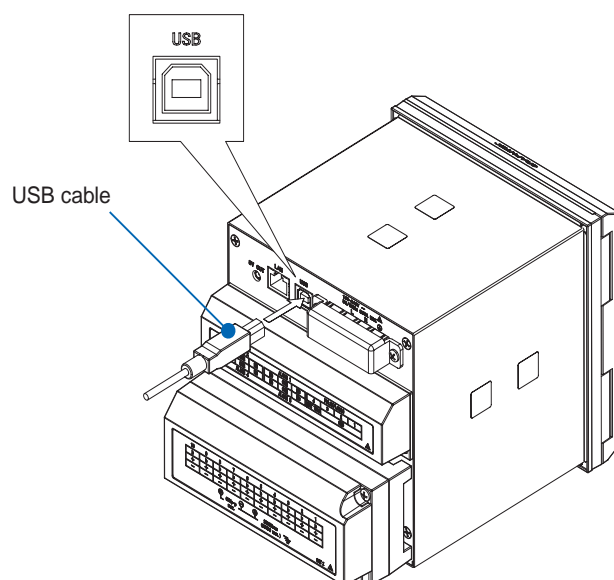

If the USB cable is used, the USB driver must be installed in your PC. Please refer to "Application Software Instruction Manual" for the installation procedure.

CAUTION

The USB connector is adjacent to the LAN connector. Make sure the cable is inserted into the correct connector.

LAN Connection

Use a LAN cable to connect the MT100 to a PC.

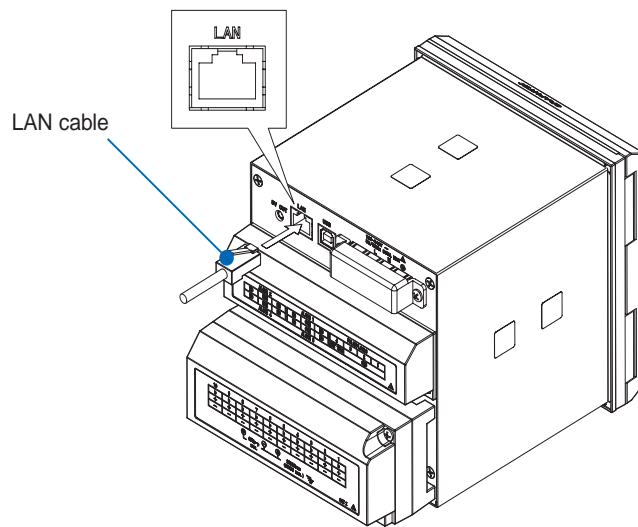

Cable Types

- Use a crossing cable when connecting directly to a PC, without using a hub.

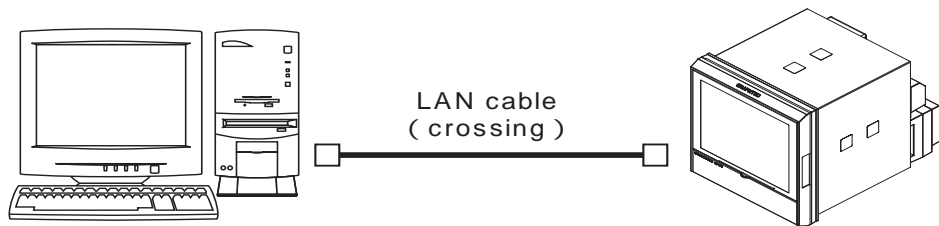

- Use a straight cable when using a hub.

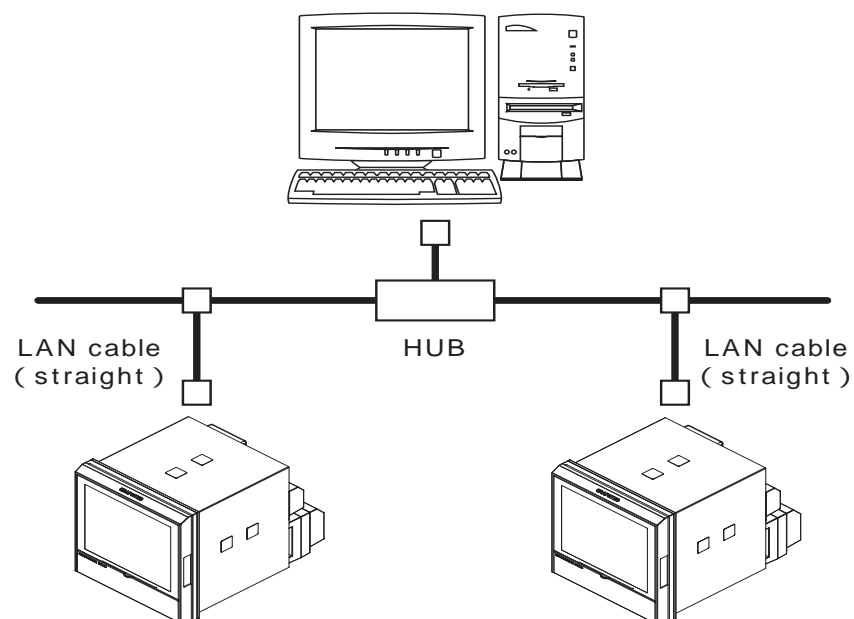

2.11 Connecting the Humidity Sensor

Connect the + and - lead wires of the humidity sensor (the B-530 option) to the desired terminals, and then insert the round connector into the 5V OUT connector on the MT100.

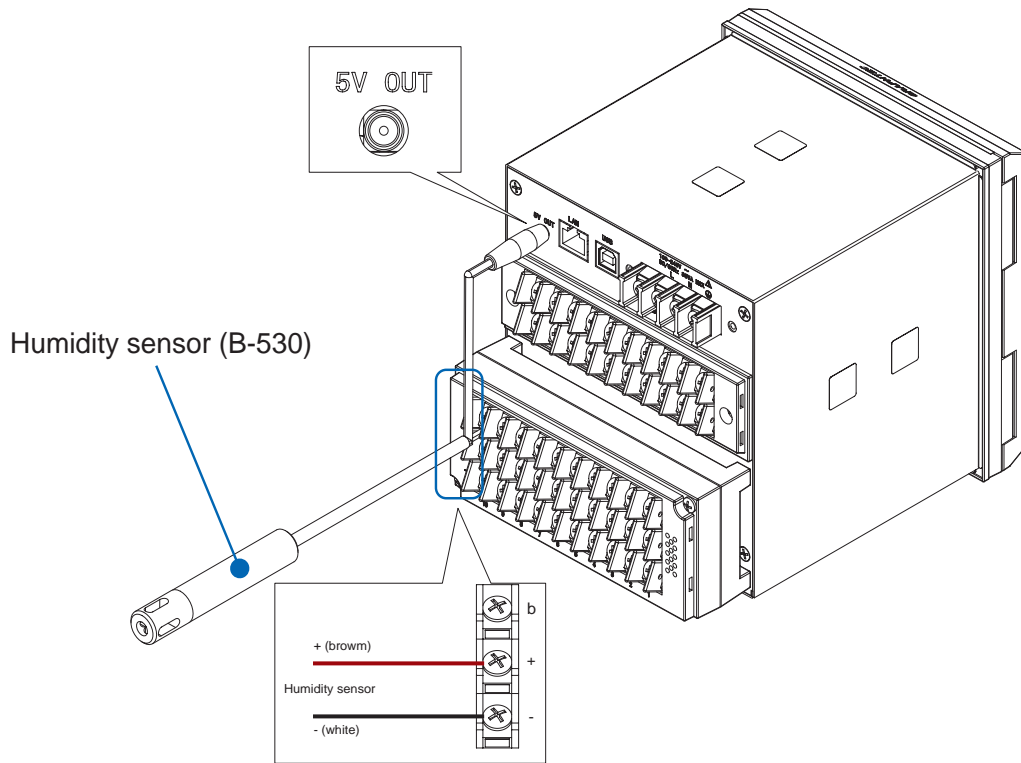

CAUTION

Do not use the sensor in a strong electrolyte environment. Measured results may not satisfy to the stated.

2.12 Attaching the Desktop Case (B-541)

This section describes how to attach the desktop case.

⚠ WARNING

Make sure the power and input signal terminal cables are removed while attaching the desktop case to avoid electric shock.

Case Set Contents

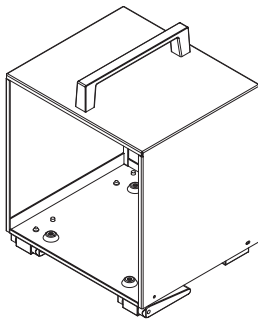

Desktop case: 1

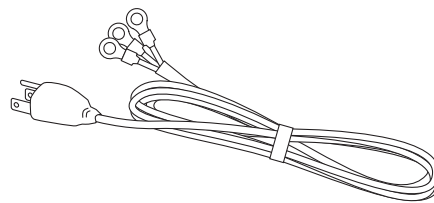

Power cable: 1



M3 x 6 mm screws: 4

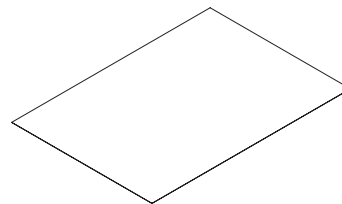

Assembly instruction manual: 1

To Attach

- (1) Insert the MT100 into the desktop case from the direction shown in the figure below.

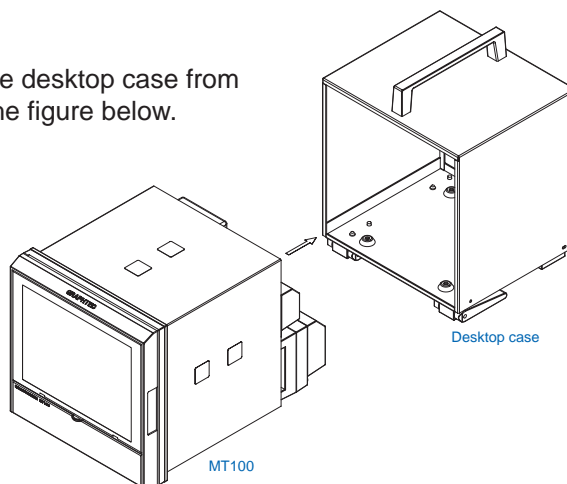

- (2) Fix the case to the device from the bottom surface using the four screws provided.
(four M3 x 6 mm binding screws)
*Recommended screw torque: 8 to 10 kgf/cm

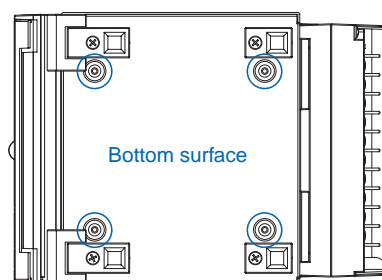

2.13 Precautions to Observe When Performing Measurement

Please be sure to read the following carefully in order to prevent electric shocks or shorts.

⚠ DANGER

- Do not apply voltage of AC30 Vrms or 60 VDC or above between the analog input section and main unit (GND terminal), or between each analog input channel.
- Do not apply radio-frequency signals with high voltage (50 KHz or above).
- The rated power supply range is 100 to 240 VAC, and the rated frequency is 50/60 Hz. Do not use any other voltages.

Input Circuit Diagram for Analog Input (Voltage, Thermocouples)

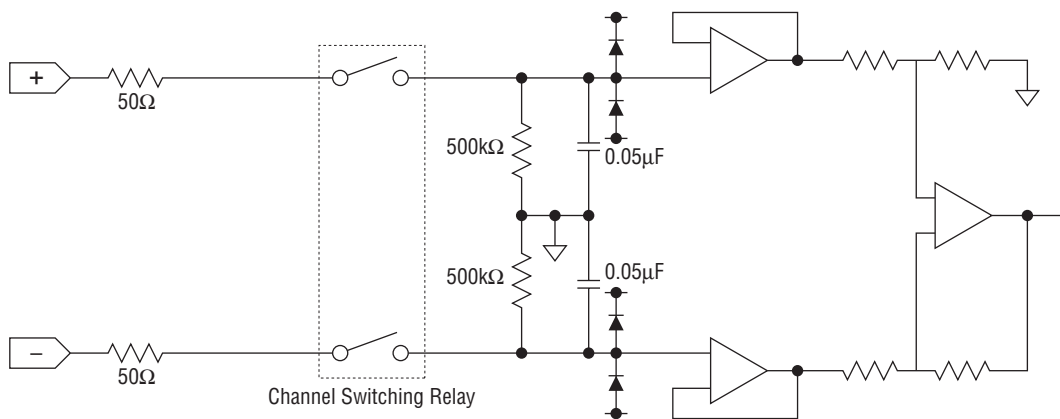

⚠ CAUTION

Capacitors have been incorporated into the input circuit to increase the noise elimination capability. After voltage measurement, when the inputs have been disconnected, there will still be some electric charge remaining. Before starting another measurement operation, short-circuit the + and - terminals to enable self-discharge.

The MT100 has a scan system.

While in the status (open) in which signals are not input to the input terminal, measured results may be influenced by signals from other channels.

In such a case, turn OFF the input setting or short circuit +/-.

If signals are input correctly, measured results are not influenced by other channels.

2.14 Noise Countermeasures

Be sure to connect the chassis GND of the object to be measured.

It may become effective by ensuring that the chassis GND wire of the measurement object is connected to a good ground.

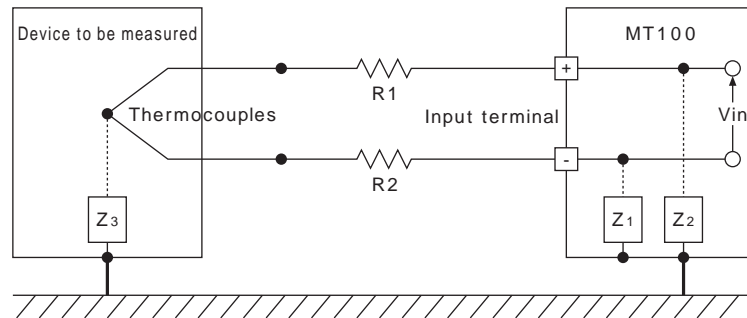

Connect the signal chassis GND and the measurement device chassis ground.

Use a short, thick lead to connect the chassis GND of the measurement object to the MC100' chassis GND. It will become even more effective if the ground potentials are the same.

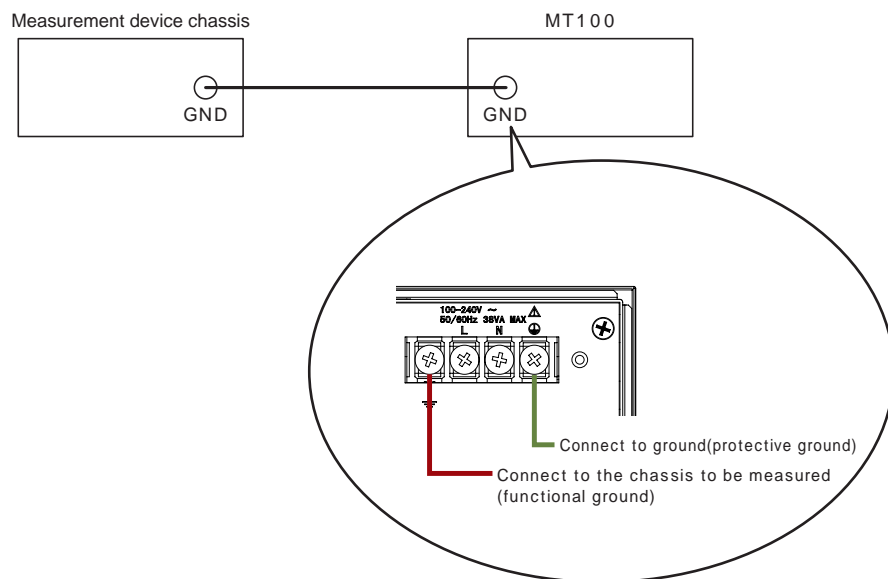

Noise Countermeasure Examples

If the measured values fluctuate due to an external noise source, try taking the following countermeasures (effects may vary according to the type of noise source).

Ex.1: Connect MT100's GND to ground.

Ex.2: Connect MT100's GND to measured object's GND.

Ex.3: In the AMP settings, set filter to value other than OFF.

Ex.4: Set a sampling interval that enables MT100's digital filter feature (500 ms or above).
In the [OTHR] menu, set the frequency of the AC line used.
Refer to page 3-39 for details.

2.15 Setting the Date and Time

If you are using the MT100 for the first time, charge the internal rechargeable battery and then make the date and time settings.

CAUTION

If the MT100 is not used for a period of approximately six months, the internal rechargeable battery may be discharged and the date and time may revert to the initial settings. If this happens, recharge the battery before using the MT100.

How to Recharge the Rechargeable Battery

Turn on the power switch and leave the MT100 connected for at least 24 hours.

How to Set the Date and Time

Press the [MENU] key, display the "OTHR" screen, and then set the date and time at the Date/Time Settings sub-menu. For details, see "Date/Time" on page 3-39.

CHAPTER 3

Settings and Measurement

This chapter describes the setting and measurement procedures for the MT100.

- 3.1 Window names and functions**
- 3.2 Key Operation**
- 3.3 Operation Modes**
- 3.4 Setting Menu**
- 3.5 Key Lock Function**
- 3.6 Exchanging USB Memory Device During Capture**
- 3.7 WEB Server Function**
- 3.8 Setting Examples**

3.1 Window names and functions

Windows

<Waveform scrolling direction:Vertical>

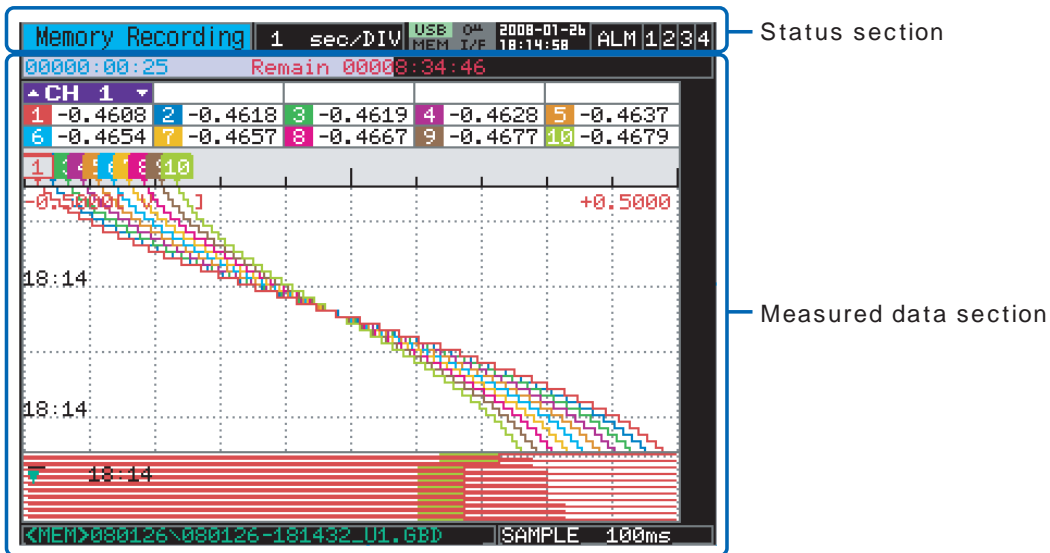

<Waveform scrolling direction:Horizontal>

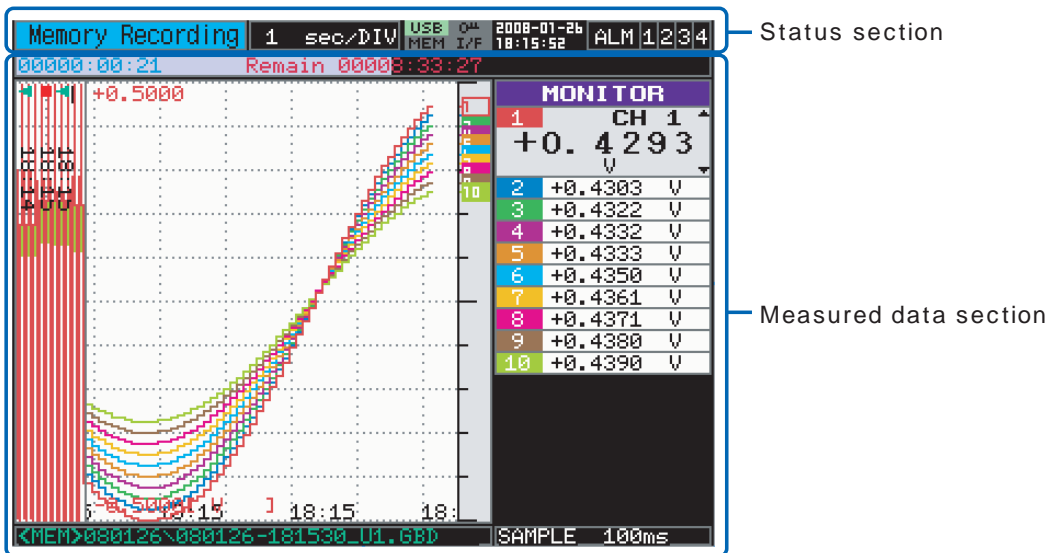

Status Section

(1) Simplified message display



Displays the operation status of the device.

- Free Running : Displayed when the device is powered ON or not performing data capture.
- Armed : Displayed when the device is waiting for a trigger to be generated after starting measurement (no data captured at this point).
- Memory Recording : Displayed while data is captured into the device's internal memory.
- USB Drv Recording : Displayed while data is captured into the USB memory.
- Memory Review : Displayed while data in the device's internal memory is being replayed.
- USB Drive Review : Displayed while data in the USB memory is being replayed.

(2) Time/DIV display



Displays the current time scale.

(3) Status display



- USB memory status display
 - USB** : USB memory is not connected.
 - USB** : USB memory is connected, but not accessed.
 - USB** : USB memory is being accessed.

⚠ CAUTION

Do not remove the USB memory and/or turn OFF the device while the USB memory is being accessed. Failure to observe this caution may result in corrupted data and data loss.

- Internal memory status display
 - MEM** : Internal memory is not accessed.
 - MEM** : Internal memory is being accessed.

⚠ CAUTION

Do not turn OFF the device while the internal memory is being accessed. Failure to observe this caution may result in corrupted data and data loss.

- Key lock status display
 - OK** : Keys are not locked. Normal key operations are allowed.
 - OK** : All keys are locked.
For details on the key lock feature, see section 3-45.
- Remote status display
 - I/F** : Local mode. Operation from the device is allowed.
 - I/F** : Remote mode. Most operations are conducted from the PC.
Disconnecting from the PC automatically sets the device back to local mode. If the mode does not return back to local mode when disconnecting the PC, press the QUIT key.

(4) Clock display



Displays the current date and time.

For details on how to set the date and time, see section 3-39.

(5) Alarm output status display



Displays the alarm output terminal status.

The number indicating the generated alarm will be displayed in red.

Measured Data Section

<Wavefome scrolling direction:Vertical>

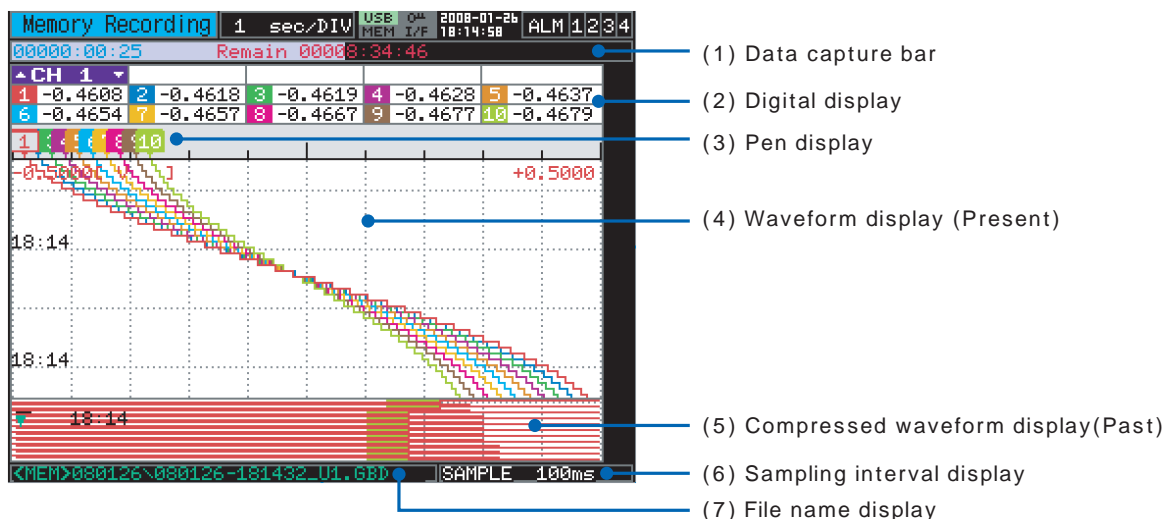

<Wavefome scrolling direction:Horizontal>

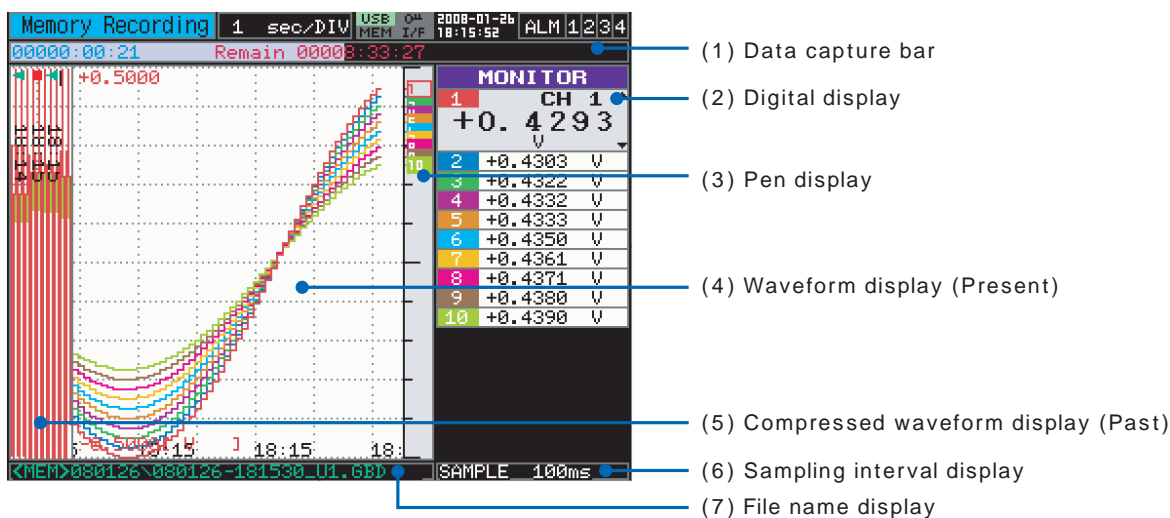

(1) Data capture bar

Indicates capture time and remaining capacity of the capturing media during data capture.
 (When the remaining capacity runs short, the display turns orange.)
 During replay, this bar shows information on the display position.

(2) Digital display

Displays the input value of each channel.
 Values set for each channel can be checked by pressing the SPAN/TRACE/POSITION key.
 For details on the SPAN/TRACE/POSITION key, see section 3-7.

(3) Pen display

Displays the position of each channel signal with icons.
 Trigger position and alarm range are also displayed.

- Trigger level display

Displays the trigger level position and direction.

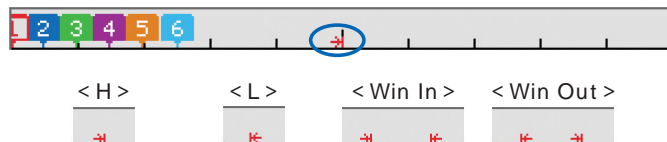

*Trigger level is also displayed when using horizontal scroll.

- Alarm range display

Displays the alarm position and range.

An alarm will be generated when a signal enters the green area shown in the figure below.
 (When an alarm is generated, the display turns red.)



*Alarm range is also displayed when using horizontal scroll.

(4) Waveform display (Present)

Displays, in real time, the measurement signals as waveforms.

(5) Compressed waveform display (Past)

Displays compressed measurement signals.
 The compression rate can be set in the menu.
 For details on how to set the compression rate, see section 3-28.

(6) Sampling interval display

Displays the currently set sampling interval.

(7) File name display

Displays the name of the file currently captured
 (displayed only during capture).

3.2 Key Operation

This section describes key operation.

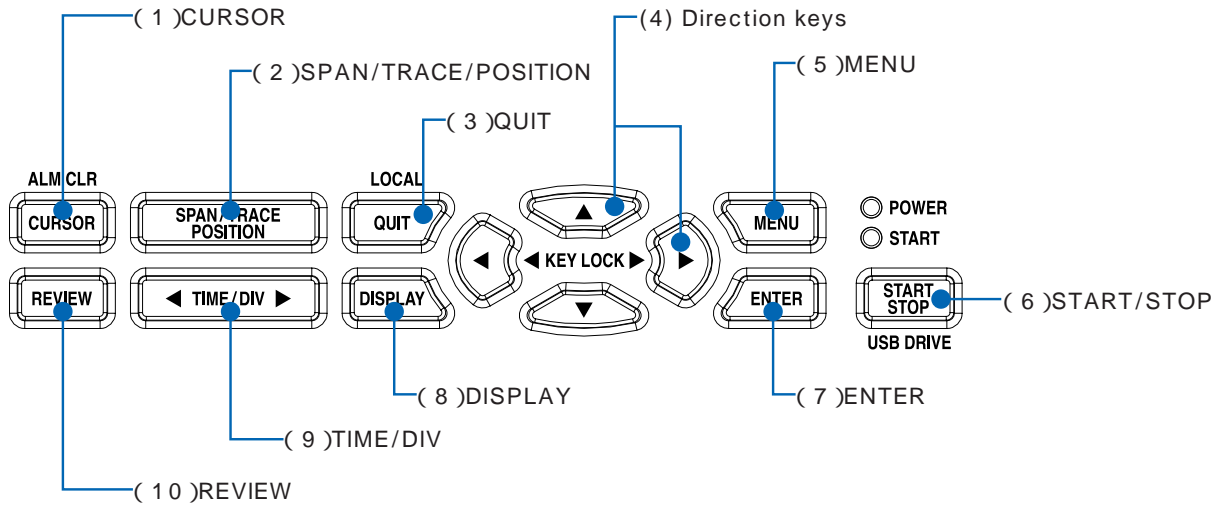

(1) CURSOR (ALM CLR)

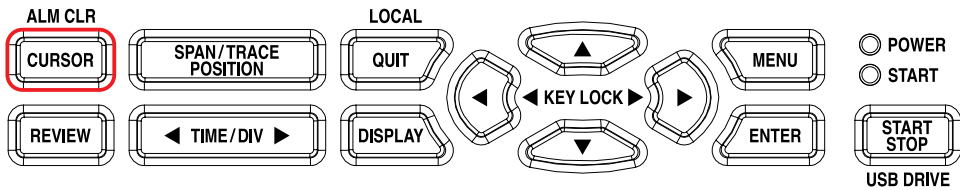

Function of this key will vary according to the operation status.

<During replay>

This key is used to toggle between cursors A and B displayed during replay.

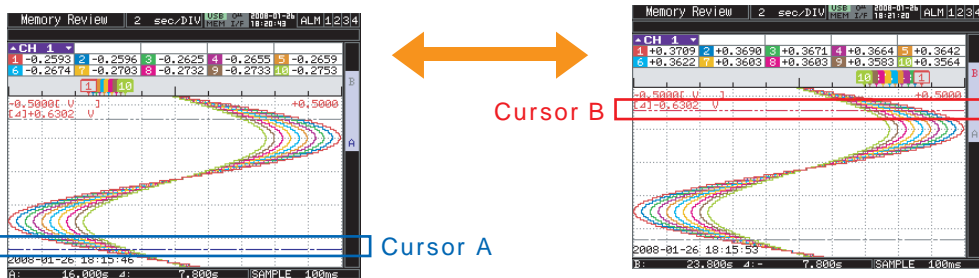

<During free running and data capturing>

When the alarm setting is "Hold generated Alarm", the maintained alarm is cleared.

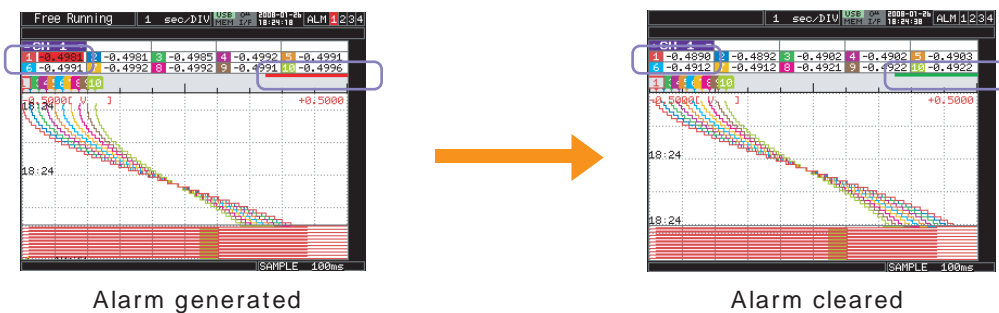

(2) SPAN/TRACE/POSITION

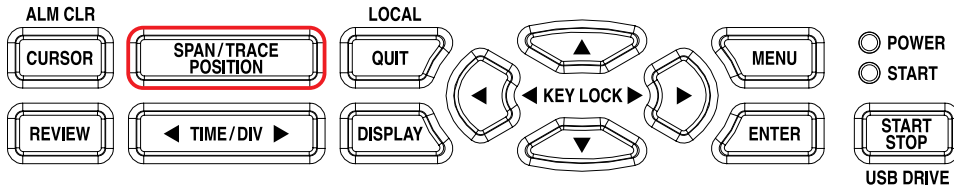

Pressing this key switches the displayed contents in the digital display.

Used to change the settings related to waveform display during free running (when stopped), data capture and data replay.

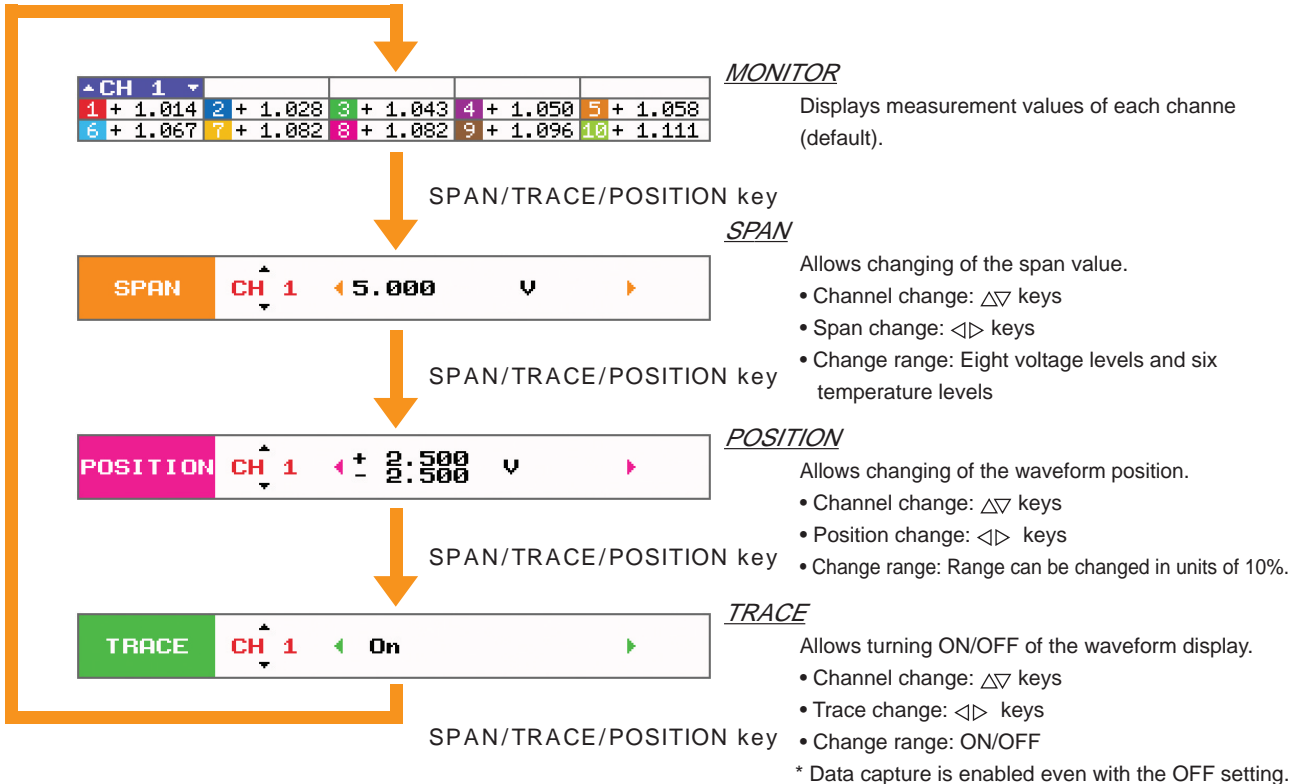

(3) QUIT (LOCAL)

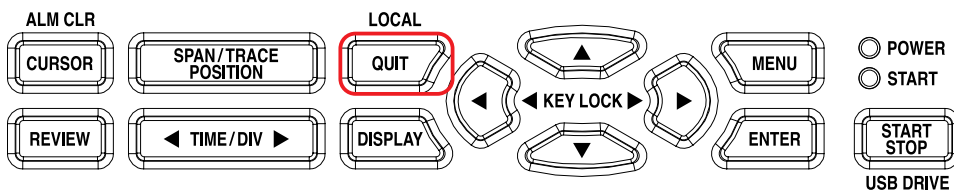

This key is primarily used for the following operations.

- To cancel a setting during menu configuration.
- To return to the MONITOR window when the SPAN/TRACE/POSITION window is displayed.
- To cancel remote status (in which keys are disabled) through interface control.
- To close the menu screen.
- To quit data replay.
- To return the Digital + Calculation Display Screen/Bar Graph Screen to the Waveform + Digital Screen.

(4) Direction keys

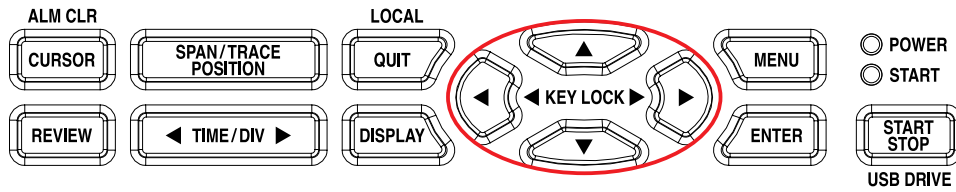

This key is primarily used for the following operations.

- To move a menu or setting item during menu configuration.
- To move the cursor during replay.
- To move the active channel in the Waveform + Digital screen ($\Delta\nabla$ keys).
- To change the setting of SPAN/TRACE/POSITION ($\triangleleft\triangleright$ keys).

(5) MENU

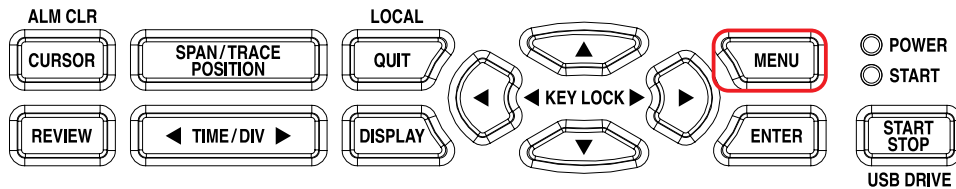

Opens the settings window to capture data. For details on settings, see "3.4 Setting Menus".

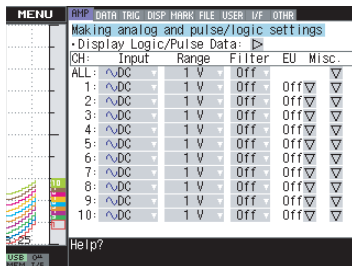

(6) START/STOP (USB DRIVE)

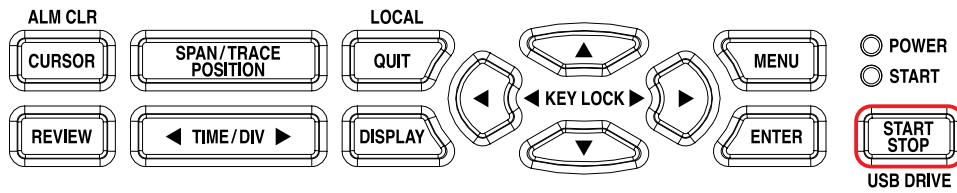

Pressing this key will perform either of the following two operations.

<Start/Stop measurement>

- Pressing this key during Free Running will start data capture.
- Pressing this key during data capture will stop capture.

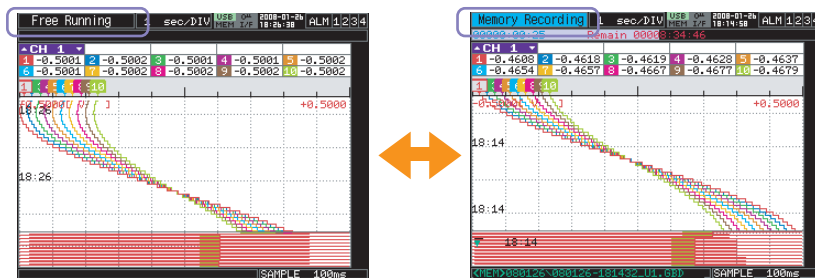

<USB Drive Mode>

In USB Drive Mode, the internal memory is recognized by the PC as an external storage media. It is acknowledged as a removable disk, which facilitates operations such as file transfer and deletion.

- (1) Use a USB cable to connect the MT100 and PC.
- (2) While pressing the MT100 START/STOP key, turn the power ON.
- (3) The external storage media is recognized by the PC, and data exchange becomes possible.

*In USB Drive Mode, the following screen is displayed.



CAUTION

- To cancel the USB Drive Mode, reboot the MT100.
- All operations, including data capture and replay, will be disabled during USB Drive Mode.

(7) ENTER

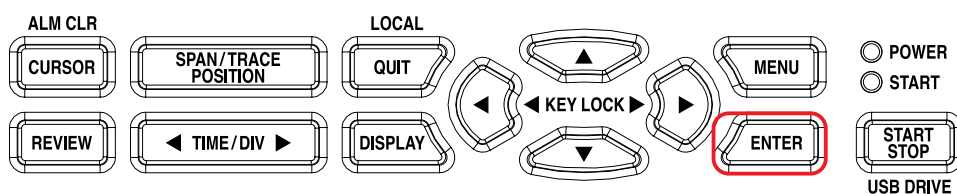

This key is used to finalize setting items during menu configuration or to open submenus.

(8) DISPLAY

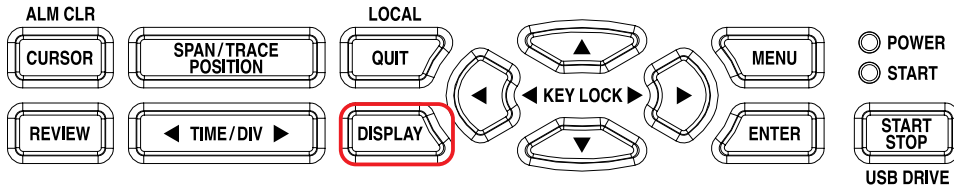

This key is used to switch data display modes.

You can switch the display modes during free running (when stopped) and capturing.

Pressing this key switches display modes as follows: Pressing this key switches display modes as follows:

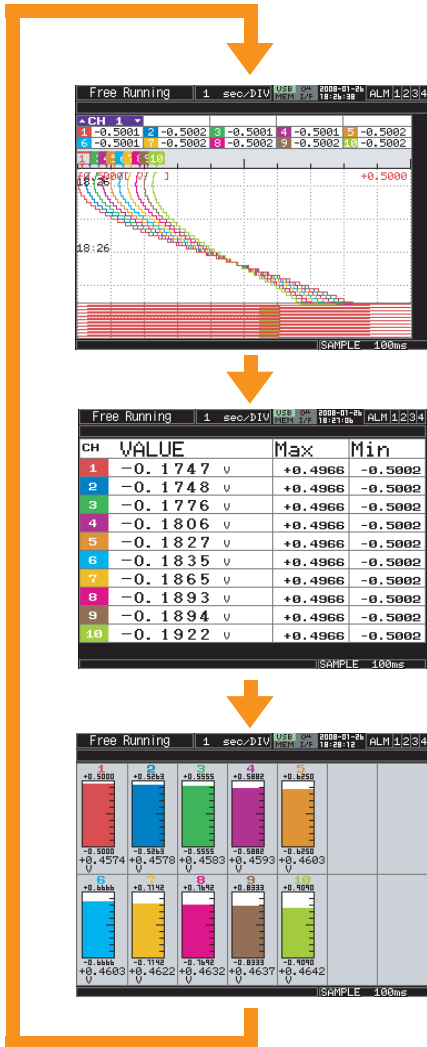

<Waveform + Digital Screen>

Displays waveforms and digital values.

This is the initial screen after device is powered ON.

<Digital + Calculation Display screen>

Displays digital values and calculation results in large text.

Calculation results are added up in real time.

For details on calculations, see section 3-23.

<Bar Graph screen>

Displays measured data as bar graphs.

You can select reference points of the bar graphs.

For details, see section 3-30.

(9) TIME/DIV

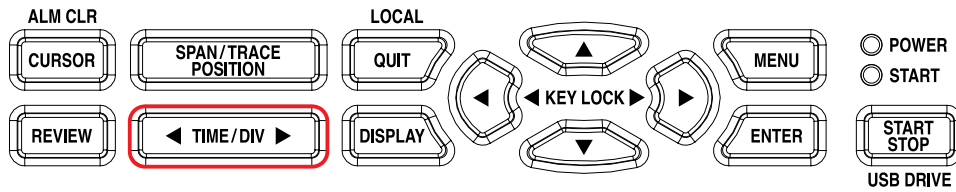

Pressing this key changes the time axis display width.
The following settings can be selected.

- 1, 2, 5, 10, 20, 30 sec/DIV
- 1, 2, 5, 10, 20, 30 min/DIV
- 1, 2, 5, 10, 12, 24, 72 hour/DIV

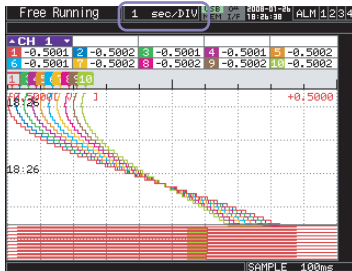

(10) REVIEW

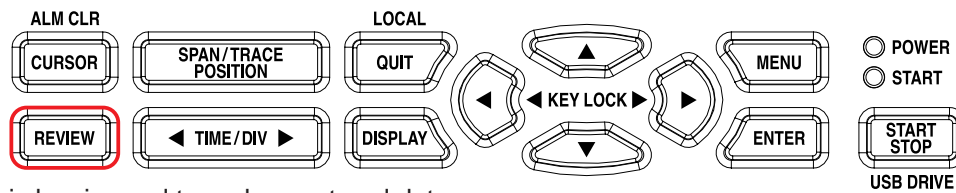

This key is used to replay captured data.

<During free running>

Replays captured data.

The screen used to specify the data replay source file appears.

Select the file to replay.

For details, see section 3-68.

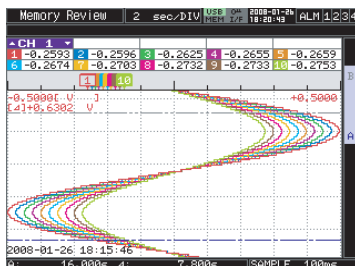

<During data capture>

Replays data currently captured, in two windows.

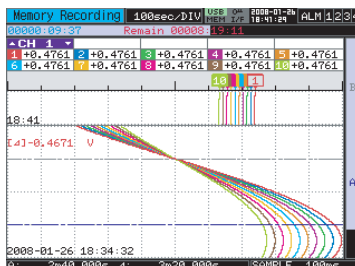

3.3 Operation Modes

You can check the system operation status in the simplified message display.

operation	operation	simplified message display
Free Running	Start up status or data is not being captured	Free Running
Capturing	Data is being captured in the main memory or USB device.	Memory Recording USB Drv Recording
Dual View Replaying	The current waveform display and data on capturing is being replayed	Memory Recording USB Drv Recording
Replaying	Captured data is being replayed	Memory Review USB Drive Review

Operation status transition

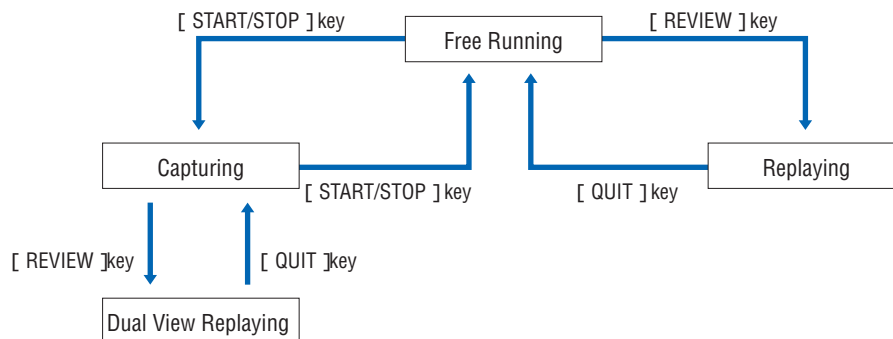

(1) Free Running

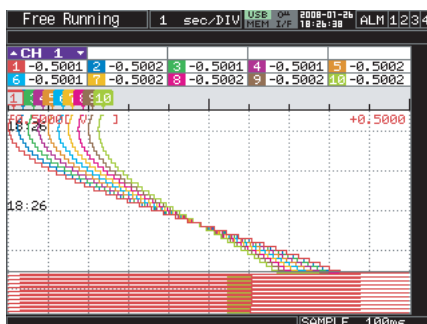

When in Free Running status, you primarily set up the system to capture data. You can check the current input signal as a waveform or digital values.

Operations available during Free Running

Measurement parameters settings	The MENU key is used to change various setting items in configuration menus.
SPAN/TRACE/POSITION	The SPAN/TRACE/POSITION key is used to change settings.
Display mode	The DISPLAY key is used to change the display mode.
Data replay	The REVIEW key is used to replay captured data.

(2) Capturing

Time of Capturing

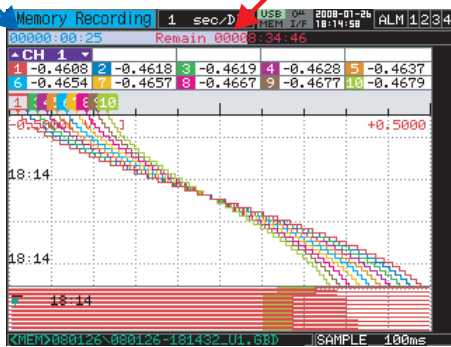

Capture time

Note: "++++:++:++" is displayed when the capture time is long.

Capture file name

During data capture, data is captured into the Internal memory or USB device. Changing settings, except for some functions, using the MENU key will be disabled.

Operations available during capture

SPAN/TRACE/POSITION	The SPAN/TRACE/POSITION key is used to change settings.
Display mode	The DISPLAY key is used to change the display mode.
Dual View replay	The REVIEW key is used to replay captured data in two windows at the same time.

(3) Dual View Replaying

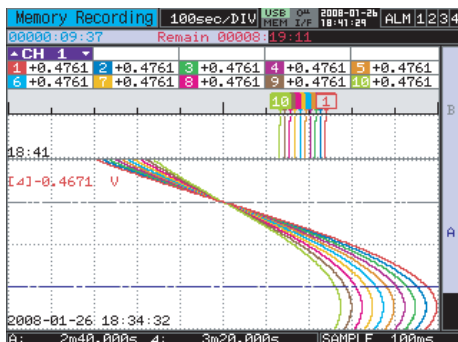

You can replay data during capture.

Waveform displayed in the upper screen (right screen, when set to horizontal scroll) is the currently captured data, and the lower screen (left screen, when set to horizontal scroll) is the previously captured data.

Operations available during dual view replaying

Moving cursor	The CURSOR key is used to switch between cursors A and B. The $\Delta \nabla$ ($\triangleleft \triangleright$) keys are used to move the cursors. The TIME/DIV key is used to zoom in/out.
---------------	--

CAUTION

- During dual view replay, only the previously captured data can be zoomed in/out using the TIME/DIV key. The view returns to its original scale when you quit replay.
- During dual view replay, the previous data will only be partly displayed. In this case, compressed data preparation bar is displayed. (compressed data will be displayed when ready).

(4) Replaying

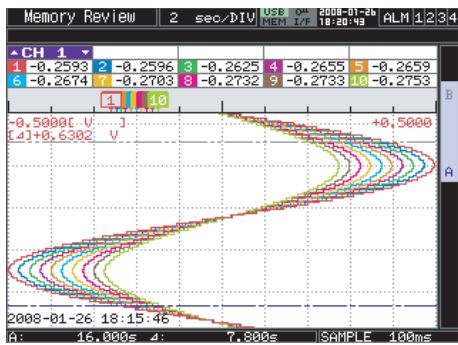

Displays captured data.

Available operation during replaying

SPAN/TRACE/POSITION	The SPAN/TRACE/POSITION key is used to change settings.
Menu operations during data replay	The MENU key is used to move the cursor, search data and set calculation.
Moving cursors	The CURSOR key is used to switch between cursors A and B. The Δ (\triangleleft) keys are used to move the cursors

3.4 Setting Menus

When you press the MENU key during Free Running, the following menu screens appear. The menu screens are classified by the tab for each setting item.



(1) AMP settings

This menu is used to specify input signal-related settings.

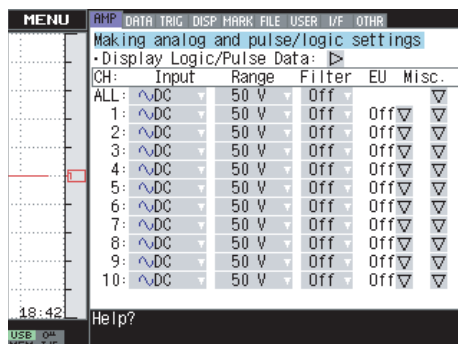

Items	Settings 1	Settings 2	Selections available	
Input			Off, DC(Voltage), TEMP(Temperature), RH(Humidity)	
Range	DC		20, 50, 100, 200, 500 mV, 1, 2, 5, 10, 20, 50, 1-5 V	
	TEMP		TC-K, TC-J, TC-T, TC-R, TC-E, TC-B, TC-S, TC-N, TC-W Pt100, JPt100, Pt1000	
Filter			Off, 2, 5, 10, 20, 40	
EU	Function		Off, ON	
(Scaling settings)	Meas. Value (Upper/Lower)		enter numerical value	
	EU Value (Upper/Lower)		enter numerical value	
	Dec pt		1, 10, 100, 1000, 10000	
	Select		Length, Area, Volume, Velocity, Accel., Freq., Mass, Energy, Pressure, Flow, Temp	
	Choose		select	
	Unit		enter text	
Misc.	CALC. Settings	CALC.	Off, ON, D/W (CH2 only, calculate with dry bulb CH1/wet bulb CH2)	
		Operation	CHn (+, -, *, /) CHn	
		Scaling	/ 1000000, / 1000, x 1, x 1000, x 1000000	
		Upper/Lower	enter numerical value	
		Dec pt	1, 10, 100, 1000, 10000	
		Select	Length, Area, Volume, Velocity, Accel., Freq., Mass, Energy, Pressure, Flow, Temp	
		Choose	select	
		Unit	enter text	
		Span settings	Upper/Lower	enter numerical value
		Annotation string		enter text (max. 11 characters)
Perform Auto Zero ADJ.		▷ Execute		
Reset Auto Zero ADJ.		▷ Execute		
Logic/Pulse	Logic/Pulse		Off, Logic, Pulse	
	Logic	Filter	Off, ON	
		Pulse	Input	Off, Revol., Counts, Inst.
			Filter	Off, ON
	Slope		H, L	
	EU	Function		Off, ON
		Meas. Value		enter numerical value
		EU Value		enter numerical value
		Select		Length, Area, Volume, Velocity, Accel., Freq., Mass, Energy, Pressure, Flow, Temp
		Choose		select
Unit		enter text		

Switching displays

Analog and logic/pulse can be switched as shown below.

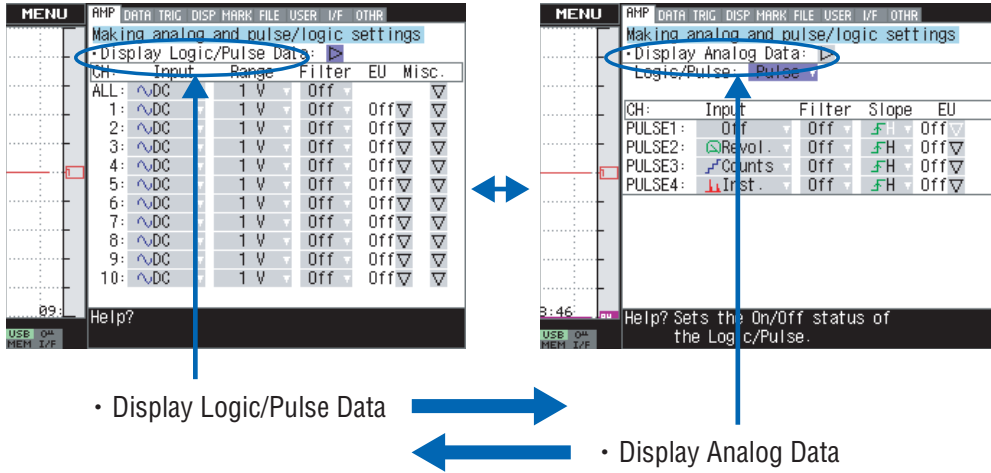

Analog settings

This screen allows you to set conditions for analog signals.



ALL and Span All Settings are set only for the currently displayed group (per 10 channels).

(1)-1 Input

Selects input conditions.

Selection items	Description
Off	No signal will be measured. † No waveform/digital display will be performed.
DC	Used for measuring direct-current voltage.
TEMP	Used for measuring temperature.
RH	Used for measuring humidity with the humidity sensor B-530. Voltage range will be set to 1 V. No EU settings are allowed.

(1)-2 Range

Selects the range of signal input to be measured.

Input settings	Description
DC	20, 50, 100, 200, 500 mV, 1, 2, 5, 10, 20, 50, 1-5 V
TEMP	TC-K, TC-J, TC-T, TC-R, TC-E, TC-B, TC-S, TC-N, TC-W Pt100, JPt100, Pt1000
RH	No selection available

<Voltage Ranges>

Range	Maximum SPAN (Measurement Range)	Minimum SPAN	Minimum Resolution
20mV	-22.000 to +22.000mV	0.200mV	0.001mV
50mV	-55.00 to +55.00mV	0.50mV	0.01mV
100mV	-110.00 to +110.00mV	1.00mV	0.01mV
200mV	-220.00 to +220.00mV	2.00mV	0.01mV
500mV	-550.0 to +550.0mV	5.0mV	0.1mV
1V	-1.1000 to +1.1000V	0.0100V	0.0001V
2V	-2.2000 to +2.2000V	0.0200V	0.0001V
5V	-5.500 to +5.500V	0.050V	0.001V
10V	-11.000 to +11.000V	0.100V	0.001V
20V	-22.000 to +22.000V	0.200V	0.001V
50V	-55.00 to +55.00V	0.50V	0.01V
1-5V	-5.500 to +5.500V	0.050V	0.001V

<Temperature Ranges>

Range	Maximum SPAN	Minimum SPAN (p-p)	Measurement Range	Minimum Resolution
K	-270 to +2000°C	50°C	-200 to +1370°C	0.1°C
J	-270 to +2000°C	50°C	-200 to +1100°C	
T	-270 to +2000°C	50°C	-200 to +400°C	
R	-270 to +2000°C	50°C	0 to +1600°C	
E	-270 to +2000°C	50°C	-200 to +800°C	
B	-270 to +2000°C	50°C	+600 to +1820°C	
S	-270 to +2000°C	50°C	0 to +1760°C	
N	-270 to +2000°C	50°C	0 to +1300°C	
W	-270 to +2000°C	50°C	0 to +2000°C	
PT100	-270 to +2000°C	50°C	-200 to +850°C	
JPT100	-270 to +2000°C	50°C	-200 to +500°C	
PT1000	-270 to +2000°C	50°C	-200 to +500°C	

<Humidity Range>

Range	Maximum SPAN	Minimum SPAN (p-p)	Minimum Resolution
	0 to +110%	1.0%	0.1%

(1)-3 Filter

Sets the filter status. Please set the filter to ON when there is likely to be noise in the input. Filter operation is on a moving average basis.

Selection items	Description
Off	No moving average will be calculated.
2	Calculates the moving average of sampling interval x 2.
5	Calculates the moving average of sampling interval x 5.
10	Calculates the moving average of sampling interval x 10.
20	Calculates the moving average of sampling interval x 20.
40	Calculates the moving average of sampling interval x 40.

About the filter Processing

This device provides a filter function that calculates the moving average as shown below.

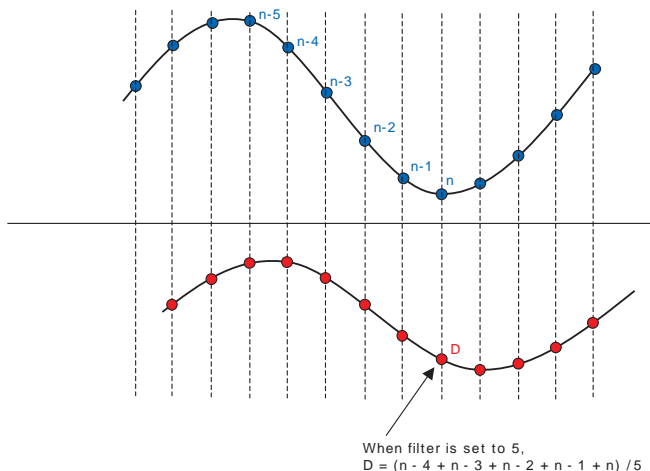

(1)-4 EU (Scaling)

Converts the measured signal into specified units.

Engineering Unit Setting			
EU:	Off ▾		
	Meas. Value	EU Value	
Upper:	+ 50.00 ▶	+ 5.000 ▶	Dec pt ▾
Lower:	- 50.00 ▶	- 5.000 ▶	
Select:	Length ▾	Choose ▾	
Unit:	V ▶		
		OK	Cancel

Setting items	Description
(1) Function	Selects the function ON/OFF.
(2) Meas. Value - Upper/Lower	Sets the upper/lower values of the numeric value to be converted.
(3) EU Value - Upper/Lower	Sets the upper/lower output values after conversion.
(4) Dec pt	Sets the decimal point position of EU values.
(5) Select	Selects the type of engineering unit (from the following). Length, Area, Volume, Velocity, Accel., Freq., Mass, Energy, Pressure, Flow, Temp
(6) Choose	Selects the converted unit. The unit displayed here is the unit type selected in the Select settings. To set a unit that is not displayed here, you can enter text in the Unit settings to set a new unit. The unit set here will be displayed in Unit.
(7) Unit	Selects the converted unit, which can be specified as a user-defined character string consisting of alphanumerics. Unit parameter can also be specified by selecting a unit in the Select settings.

CHECKPOINT

- If a message appears, follow the instructions by reducing the number of digits to be output by one, or leaving the number of digits as is and changing the EU value.
- The Scaling operation is calculated using a ratio of the Meas. Value or EU Output Value settings. "+++/----" is displayed when the converted value cannot be processed by MT100. Span may be changed according to the value set for Scaling.

Setting Example

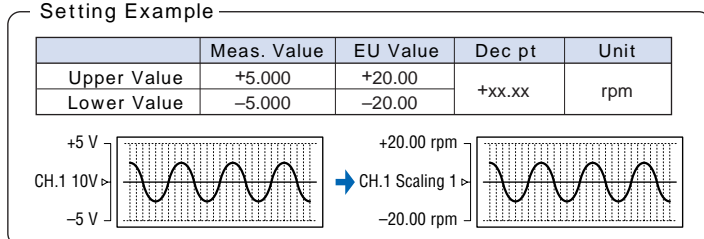

(1)-5 Misc.

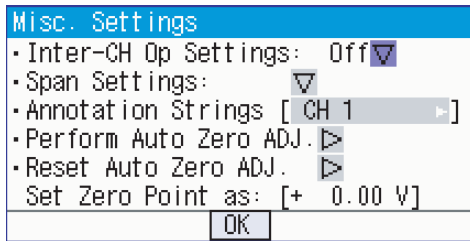

Setting items	Description
(1) Inter-CH Op Settings	Sets which calculation to perform between channels. Four arithmetic operations (+, -, *, /) can be selected. Humidity can be calculated using dry bulb/wet bulb (CH2 only). *For details, see next page.
(2) Span settings	Sets the upper/lower span values of the displayed waveforms.
(3) Annotation string	Sets annotations (comments) to be displayed for each channel. Maximum of 11 characters can be entered. Enter the text string using alphanumerics.
(4) Perform Auto Zero ADJ	Calculates the current input voltage as the zero position voltage value.
(5) Reset Auto Zero ADJ.	Cancels the zero position voltage value and displays the input voltage.
(6) [Set Zero Point as]	Displays the zero point voltage value (display only).

CALC. Settings (1)

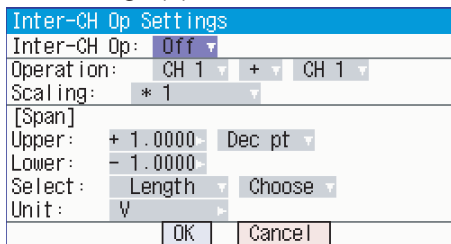

Setting items	Description
(1) Inter-CH Op Settings	Off, ON, D/W (humidity) D/W (humidity) calculates humidity with CH1 dry bulb and CH2 wet bulb input values. In D/W (humidity), CH1/CH2 are temperature settings. Only CH2 can be selected.
(2) Operation	CH-X, Function, CH-Y CH-X Select from CH1 to CH10. Function Arithmetic operations (+, -, *, /) CH-Y Select from CH1 to CH10.
(3) Scaling	/ 1000000, / 1000, x 1, x 1000, x 1000000 Selects the display method of calculated results. <Ex.> calculated result = 0.001 calculated result = 1000 x 1 : 0.001 x 1 : 1000 x 1000 : converts to 1. / 1000 : converts to 1. x 1000000 : converts to 1000. / 1000000 : converts to 0.001.
(4) Upper/Lower	Sets the upper/lower span values of the displayed waveforms. The values set here will be applied to calculated results.
(5) Dec pt	Selects the decimal point position of span settings.
(6) Select	Selects the display unit for calculation results. Length, Area, Volume, Velocity, Accel., Freq., Mass, Energy, Pressure, Flow, Temp
(7) Choose	Selects the converted unit. The unit displayed here is the unit type selected in the Select settings. To set a unit that is not displayed here, you can enter text in the [Unit] settings to set a new unit. The unit set here will be displayed in Unit.
(8) Unit	Selects the converted unit, which can be specified as a user-defined character string consisting of alphanumerics. Unit parameter can also be specified by selecting a unit in the Select settings.



- Calculation results will be displayed in "V" (Volts).
If you calculate "100 mV + 100 mV", the result will be displayed as "0.2".
To display the result as "200 mV", change the scaling settings.

- The formula to calculate humidity using dry and wet bulb temperatures is as follows:

$$\text{humidity}[\%] = \frac{E(t_w) - K \times P \times (t_d - t_w)}{E(t_d)} \times 100$$

- td : dry bulb temperature (1 ch)
- tw : wet bulb temperature (2 ch)
- K : constant (0.000662, when wet bulb is not frozen)
- P : barometric pressure (101325)
- E(t) : saturated vapor pressure at temperature t (JIS standard)

Logic and Pulse settings

This screen allows you to set conditions for digital inputs.

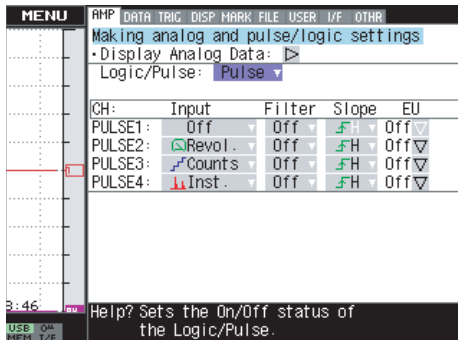

Setting items	Description	
Logic/Pulse	Selects the process method performed on digital input.	
	Off	Digital input will not be measured.
	Logic	Processes digital input as logic signals.
	Pulse	Processes digital input as pulsesignals.
<When digital input is "logic">		
Filter	Sets the filter for logic input.	
	Off	Disables the hardware filter.
	ON	Enables the hardware filter. Filter function can be effective when measurements areperformed in noisy environments. Filter is approximately 30 Hz (- 3dB).
<When digital input is "pulse">		
Input	Sets the pulse measurement mode.	
	Off	Pulse input will not be measured.
	Revol.	Counts the number of pulses per second, multiply it by 60, and captures that value as rpm values.
	Counts	Captures the cumulative number of pulses for each sampling interval from the start of measurement.
	Inst.	Captures the number of pulses for each sampling interval.
Filter	Sets the filter for pulse input.	
	Off	Disables the hardware filter.
	ON	Enables the hardware filter.† Filter function can be effective when measurements areperformed in noisy environments. Filter is approximately 30 Hz (-3dB).
Slope	Sets the slope (direction) to count the number of pulses.	
	H	Counts the rising pulses.
	L	Counts the falling pulses.
EU	Sets scales for pulse measurement values.	

(1)-6 Pulse EU settings

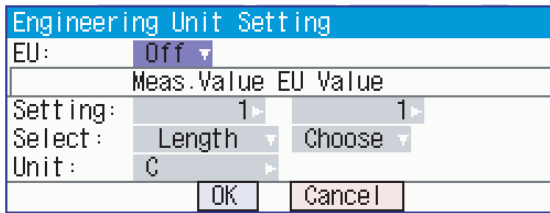

Setting items	Description
(1) Function	Selects ON/OFF of the scaling function.
(2) Meas. Value	Sets the upper value of the numeric value to be converted
(3) EU Value	Sets the upper output value after conversion.
(4) Select	Selects the type of engineering unit (from the following) Length, Area, Volume, Velocity, Accel., Freq., Mass, Energy, Pressure, Flow, Temp
(5) Choose	Selects the converted unit. The unit displayed here is the unit type selected in the Select settings. To set a unit that is not displayed here, you can enter text in the Unit settings to set a new unit. The unit set here will be displayed in Unit.
(6) Unit	Selects the converted unit, which can be specified as a user-defined character string consisting of alphanumerics. Unit parameter can also be specified by selecting a unit in Select.

CAUTION

- If a message appears, follow the instructions by reducing the number of digits to be output by one, or leaving the number of digits as is and changing the EU value.
- The Scaling operation is calculated using a ratio of the Meas. Value or EU Output Value settings. "++++/----" is displayed when the converted value cannot be processed by MT100. Span may be changed according to the value set for Scaling.

(2) DATA settings

This menu is used to specify capture-related items and calculations.

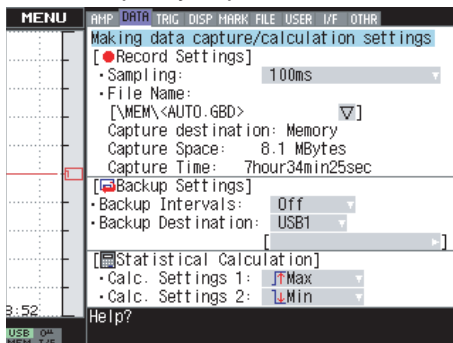

Items	Settings 1	Settings 2	Selections available
Record Settings	Sampling Interval		100, 125, 200, 250, 500 ms, 1, 2, 5, 10, 20, 30 s, 1, 2, 5, 10, 20, 30 min, 1 h
	File Name	File Name	Capture destination : MEM, USB1 Folder : enter text string File Name : enter text string (when Name Type is set to Auto)
		Name Type	Auto, User, SN
		File Type	GBD, CSV
Backup Settings	Backup Intervals		Off, 1, 2, 6, 12, 24 h
	Backup Desination	Backup Desination	USB1, FTP
		Folder Name	enter text string
Statistical Calculation	Calc. settings 1		Off, Average, Max, Min, Peak, RMS
	Calc. settings 2		Off, Average, Max, Min, Peak, RMS

(2)-2 Backup Settings

MT100 provides a back up function where captured data can be backed up periodically (see figure below). This section allows you to set data back up conditions.

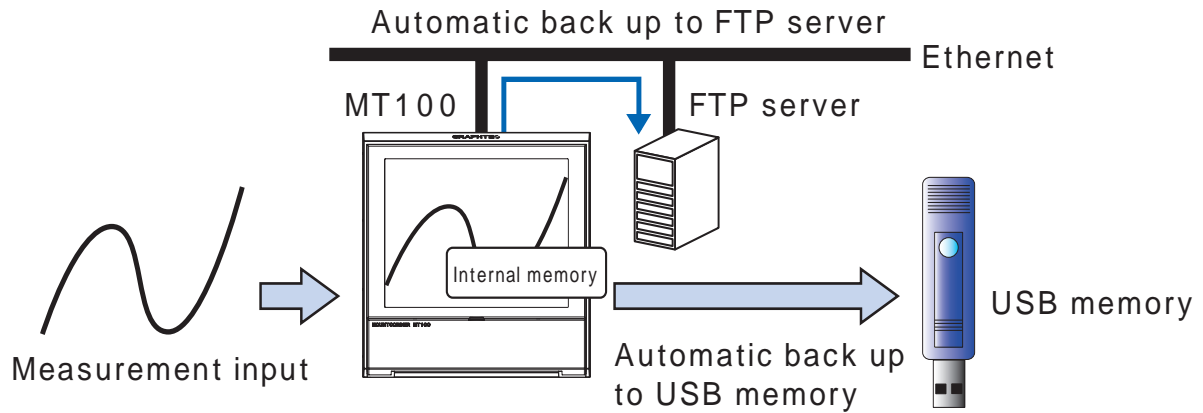

Setting items	Description	
Backup Intervals	Sets the interval to perform back up of captured data. Off, 1, 2, 6, 12, 24 h	
Backup Desination	Sets the location where back up data will be stored.†	
	USB1	Data is backedup in the USB memory. This is enabled only when data is captured in the internal Flash memory.
	FTP	Data is backed up in the FTP server in the network. * FTP settings in the FILE menu is required (see 3-32).
Folder Name	Specifies the folder where data will be saved. ex) \GRAPHTEC\TEST\20071204	

(2)-3 Statistical Calculation

Two calculations can be performed in MT100. This section allows you to set details of the statistical calculation.

Setting items	Description	
Calc. Settings 1 (2)	off	Calculation is not performed.
	Average	Displays the simple average value during data capture.
	Max	Displays the maximum value during data capture.
	Min	Displays the minimum value during data capture.
	Peak	Displays the peak value data during data capture.
	RMS	Displays the effective value of the data during data capture. The following formula is used. $R.M.S = \sqrt{D^2/n}$ * <i>D</i> : data <i>n</i> : number of data



- Operation results are displayed in the Digital + Calculation Display screen.
- Calculation will start upon power ON. Pressing the Start key to begin measurement will clear the calculation.

(3) TRIG settings

This menu is used to specify trigger conditions and alarms.

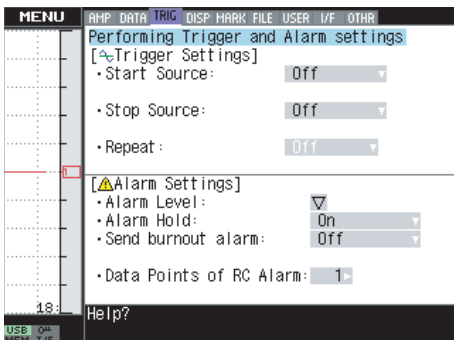

Items	Settings 1	Settings 2	Selections available	
Trigger Settings	Start Source		Off, Level, Alarm, Ext., Date, Weekly	
	Off		None	
	Level	Combination	Mode	OR, AND
				Analog : Off, H, L, Win In, Win Out Pulse : Off, H, L, Win In, Win Out Logic : Off, H, L
			Level	set numeric value
	Alarm	Alarm port number	1, 2, 3, 4	
	External input		None	
	Date		Date, Time	
	Weekly		Weekly, Time	
	Stop Source		Off, Level, Alarm, Ext., Date, Weekly, Time	
	Off		None	
	Level	Combination	Mode	Analog : Off, H, L, Win In, Win Out Pulse : Off, H, L, Win In, Win Out Logic : Off, H, L
			Level	set numeric value
			Alarm	Alarm port number
	External input		None	
	Date		Date, Time	
	Weekly		Weekly, Time	
Time		1 s to 9999 h 59 min 59 s		
Repeat	Repeat		Off, ON	
	Repeat interval		1 min to 199 h 59 min	
Alarm Settings	Alarm Level settings	CH	CH1 to CH10, Pulse1 to Pulse4, LOGIC	
		Mode	Off, H, L, Win In, Win Out, RC	
		Level	set numeric value	
		Output	1, 2, 3, 4	
	Alarm Hold		On, Off	
	Send burnout alarm		On, Off	
	Data points of RC Alarm		1 to 32	

(3)-1 Trigger Settings

This section allows you to set conditions for data capture start and stop.

Setting items	Description	
Start Source	Specifies conditions to start capture.	
	Off	Starts capture when the START key is pressed.
	Level	Starts capture when specified conditions are met for a set level. => If you select Level, you must also set the conditions for each channel (see 3-26).
	Alarm	Starts capture when the alarm with the specified number is generated. => If you select Alarm, you must also specify the alarm number to trigger the capture operation. Alarm number : No1 to No4
	Ext.	Starts capture when an input signal is received from an external trigger terminal. * Trigger is generated when 5 V (open) becomes 0 V (shorted to GND).
	Date	When Repeated capturing is set to Off: Starts capture when the specified date and time arrive. When Repeated capturing is set to On: Starts capture when the specified time arrives. => If you select Date, you must also set the date and time to begin the capture operation. * When Repeated capturing is set to ON, only time must be set. This setting is used when you want to start capturing data at the same time every day.
	Weekly	Starts capture when the specified day and time arrive. => If you select [Weekly], you must also set the day and time to begin the capture operation.
Stop Source	Specifies conditions to stop capture.	
	Off	Starts capture when the STOP key is pressed.
	Level	Stops capture when specified conditions are met for a set level. => If you select Level, you must also set the conditions for each channel (see 3-26).
	Alarm	Stops capture when the alarm with the specified number is generated. => If you select Alarm, you must also specify the alarm number to stop the capture operation. Alarm number : No1 to No4
	Ext.	Stops capture when an input signal is received from an external trigger terminal. * Trigger is generated when 5 V (open) becomes 0 V (shorted to GND).
	Date	When Repeated capturing is set to Off: Stops capture when the specified date and time arrive. When Repeated capturing is set to On: Stops capture when the specified time arrives. => If you select Date, you must also set the date and time to stop the capture operation. * When Repeated capturing is set to ON, only time must be set. This setting is used when you want to stop capturing data at the same time every day.
	Weekly	Stops capture when the specified day and time arrive. => If you select [Weekly], you must also set the day and time capture operation should stop.
Repeat	Time	Stops capture when a specified duration time has elapsed. => If you select Time, you must also set the duration of the capture operation.
	Sets ON/OFF of the repeated capturing.	
	Off	Disables repeated capturing. Waits for start trigger → Starts capture → Waits for stop trigger → Stops capture
ON	Enables repeated capturing. Repeats the following: Waits for start trigger → Starts capture → Waits for stop trigger → Stops capture → Waits for repeat time → Waits for start trigger ... => If you set Repeated capturing ON, you must also set the repeat time. After the specified time has elapsed, state will return back to "trigger wait".	

Detailed settings of Level values

If the trigger source settings are set to Level, you must set further conditions for each channel. The following diagram shows the overall structure of level trigger.

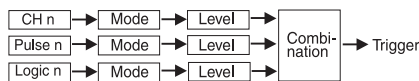

* Switch between Pulse and Logic modes.

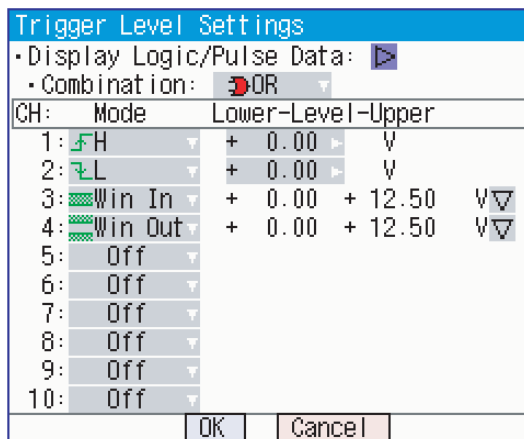

Setting items	Description
(1) Combination	Sets the combination of trigger conditions set for each channel.
	OR Starts (stops) capture when one or more trigger conditions have been met.
	AND Starts (stops) capture when all trigger conditions have been met.
(2) Mode	Sets the mode to compare triggers for each channel.
	Off Disables the trigger set for the channel.
	H A trigger is generated when the input signal is above the specified level.
	L A trigger is generated when the input signal is below the specified level.
	Win In A trigger is generated when the input signal is within the specified upper and lower limits for each channel. * No settings for Logic channels.
	Win Out A trigger is generated when the input signal is outside of the specified upper and lower limits for each channel. * No settings for Logic channels.
(3) Level	Sets the level to compare triggers.
	When Mode is H or L, set one compare level.
	When Mode is Win In or Win Out, set two compare levels.

(3)-2 Alarm Settings

This section allows you to set conditions for alarm comparison.

Setting items	Description
Alarm Level settings	Sets the conditions to perform alarm comparison. For details, see 3-27.
Alarm Hold	Sets the status after an alarm has been generated.
	Off Alarm is canceled when the input signal is cancelled after an alarm has been generated.
	On Alarm will not be cancelled when the input signal is cancelled after an alarm has been generated. In this case, pressing the CURSOR key will cancel the alarm.
Data Points of RC Alarm	If you set RC for Alarm Settings, you must set the number of points to calculated the change. An alarm is generated when the amount of alteration in data is equal to or greater than the specified value, after the number of specified samples have elapsed.

Detailed settings of Level values

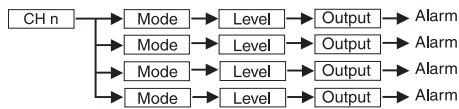

*Four settings are available for the Alarm Settings for each analog/pulse channel.

Alarm Level Settings				
Ch:	CH 1			
SET:	Mode	Lower-Level-Upper	Output	
1:	H	+ 0.00	V	1
2:	L	+ 0.00	V	2
3:	Win In	+ 0.00 + 12.50	V	3
4:	RC	+ 0.00	V	4
		OK	Cancel	

Setting items	Description	
(1) CH	Selects the channel to set an alarm. Four types of alarms can be set for each analog/pulse channel.	
(2) Mode	Sets the conditions to perform alarm comparison.	
	Off	Disables alarm comparison.
	H	An alarm is generated when the input signal is above the specified level.
	L	An alarm is generated when the input signal is below the specified level.
	Win In	An alarm is generated when the input signal is within the specified upper and lower limits for each channel. * No settings for Logic channels.
	Win Out	An alarm is generated when the input signal is outside of the specified upper and lower limits for each channel. * No settings for Logic channels.
(3) Level	Sets the level to perform alarm comparison.	
	When Mode is H or L, set one compare level.	
	When Mode is Win In or Win Out, set two compare levels. When Mode is RC, set the rate of change (difference).	
(4) Output	Sets the number to be output when an alarm is generated. Output relay will be ON/OFF synchronous to the specified number.	

(3)-3 About the Trigger and Alarm Operations

H: A trigger/alarm is generated when the signal input rises to (or exceeds) the specified level.

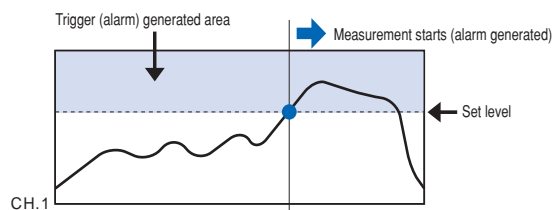

L: A trigger/alarm is generated when the signal input falls to (or falls below) the specified level.

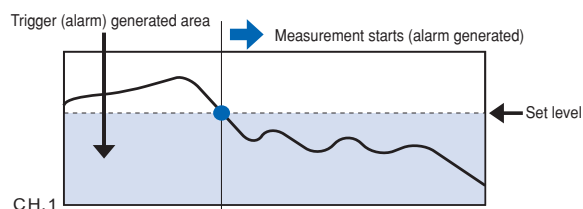

Win In: Used to specify the upper and lower limits for each channel. When the signal level goes within (or is within) either limit, a trigger/ alarm is generated.

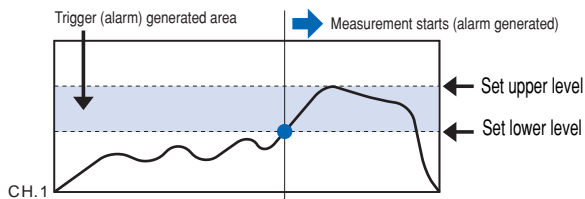

Win Out: Used to specify the upper and lower limits for each channel. When the signal level goes outside (or is outside) either limit, a trigger/ alarm is generated.

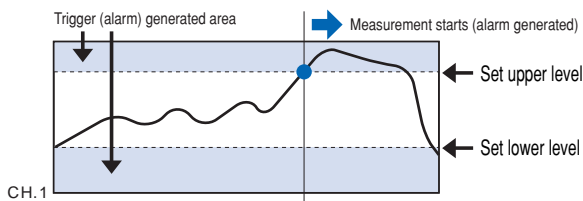

Rate of Change Alarm

Ex) When Data Points of RC Alarm is set to 3.

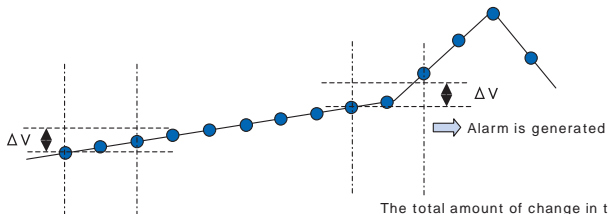

The total amount of change in the three points exceeds the specified value (ΔV). An alarm is generated.
 The total amount of change in the three points is equal to or less than the specified value (ΔV). Alarm is not generated.

(4) DISP settings

This menu allows you to make display-related settings.

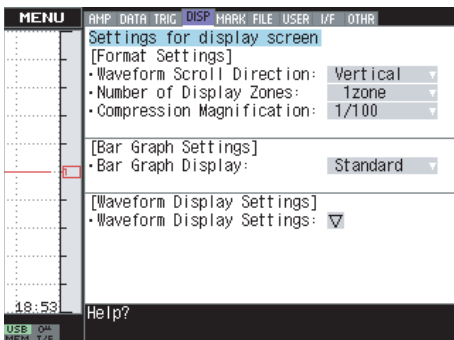

Items	Settings 1	Settings 2	Selections available
Format Settings	Waveform Scroll Direction		Vertical, Horizontal
	Number of Display Zones		1, 2, 5, 10 zone
	Compression Magnification		1/10, 1/20, 1/30, 1/40, 1/50, 1/60, 1/70, 1/80, 1/90, 1/100
Bar Graph Settings	Bar Graph Display		Standard, Center
Waveform Display Settings	Color		red: 0 to 31, green: 0 to 31, blue: 0 to 31
	Width		1, 2, 3, 4, 5, 6, 7, 8 dots
	Trace		On, Off

(4)-1 Format Settings

This section allows you to set the format to display analog waveforms.

Setting items	Description	
Waveform Scroll Direction	Vertical	Allows scrolling in the vertical direction (up to down).
	Horizontal	Allows scrolling in the horizontal direction (left to right).
Number of Display Zones	Sets the number of sections (zones) in which waveforms are displayed.	
	1zone	Displays waveforms from all channels in one zone.
	2zone	Displays waveforms in two zones (Ch 1 to 5 in one zone, Ch 6 to 10 in another).
	5zone	Displays two waveforms each in five zones.
10zone	Displays each waveform separately in 10 zones.	
Compression Magnification	Sets the compression rate for the waveforms to be displayed in the Compressed waveforms display (previous).	

Waveform Scroll Direction

<Waveform Scrolling Direction:Vertical>

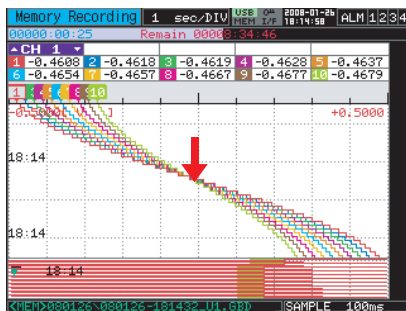

<Waveform Scrolling Direction:Horizontal>

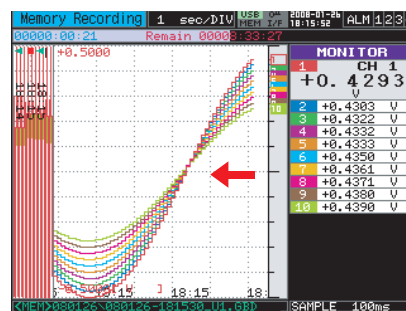

Number of Display zones

<When set to 2 zone>

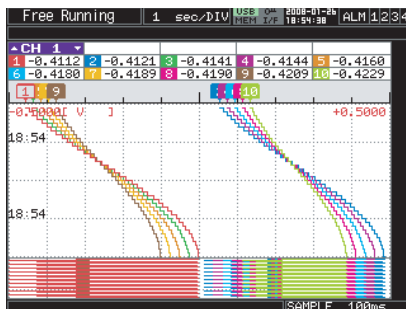

<When set to 10 zone>

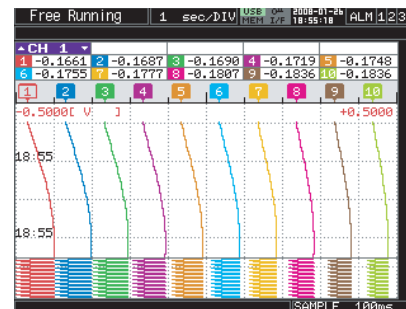

Compression Magnification

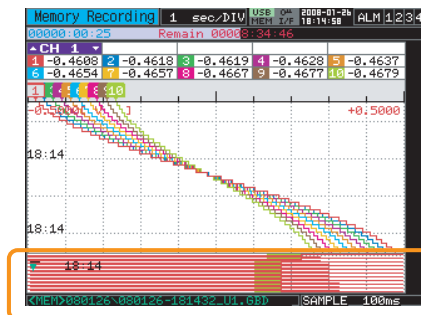

← Sets the compression rate to display waveforms in this area.

(4)-2 Bar Graph Settings

This section allows you to select the display method of bar graphs.

Setting items	Description	
Bar Graph Settings	Standard	Displays the bar graph with the reference point set to the bottom of the bar.
	Center	Displays the bar graph with the reference point set to the center of the bar.

<Standard>

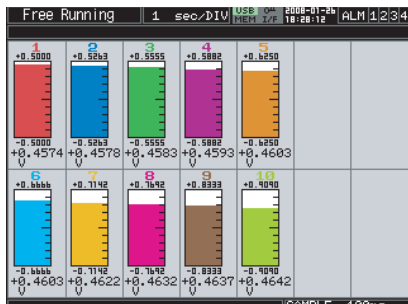

<Center>

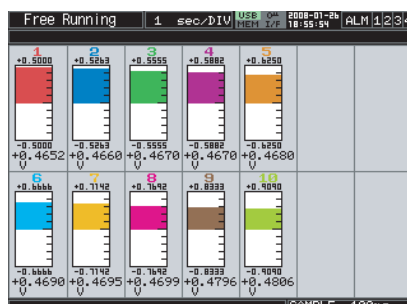

(4)-3 Waveform Display Settings

This section allows you to set the display color, line width, and display ON/OFF of each waveforms.

Waveform Settings			
• Display Logic/Pulse Data: ▾			
CH:	Color	Width	Trace
1:	■	1 dot ▾	On ▾
2:	■	1 dot ▾	On ▾
3:	■	1 dot ▾	On ▾
4:	■	1 dot ▾	On ▾
5:	■	1 dot ▾	On ▾
6:	■	1 dot ▾	On ▾
7:	■	1 dot ▾	On ▾
8:	■	1 dot ▾	On ▾
9:	■	1 dot ▾	On ▾
10:	■	1 dot ▾	On ▾
OK			

Setting items	Description	
(1) Color	Sets the waveform display color for each channel. Colors can be set by specifying the RGB values from 0 to 31, or by selecting from 10 default colors.	
(2) Width	Sets the line width of the displayed waveforms. Values can be specified from 1 to 8 dots.	
(3) Trace	Enables/disables waveform display.	
	ON	Enables waveform display.
	OFF	Disables waveform display. Data capture can be performed.

(5) MARK settings

This menu allows you to set marks or icons displayed on the waveforms.

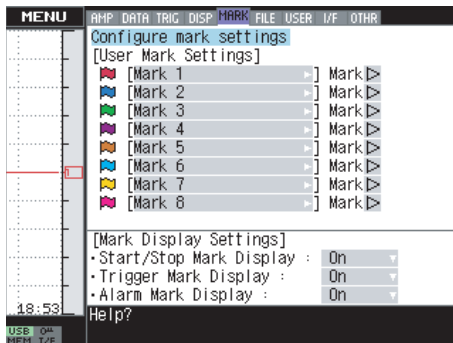

Items	Settings 1	Settings 2	Selections available
User Mark Settings	Mark1 to 8		Enter alphanumerics. Up to 30 characters can be used.
Mark Display Settings	Start/Stop Mark Display		On, Off
	Trigger Mark Display		On, Off
	Alarm Mark Display		On, Off

(5)-1 User Mark Settings

You can register a text string to be displayed on the screen as user-defined icons, according to need. There are eight types of user-defined marks that can be registered.

To display a user-defined icon, press the ENTER key on the Mark \triangleright on the menu.

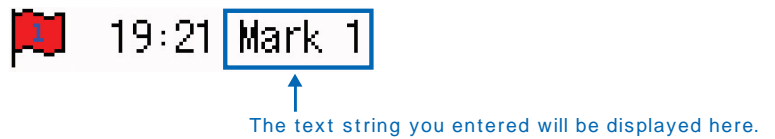
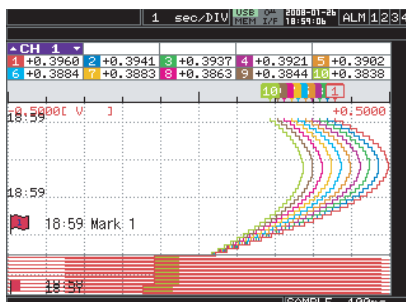

CHECKPOINT

- The displayed user-defined icons will also be stored in the captured data.
- There is no restriction on how many icons that can be displayed. However, note that information on these icons are stored in the data file and will thus effect the data file size. 22 single-byte characters can be displayed when using horizontal scroll.

(5)-2 Mark Display Settings

You can display three types of system indicators, along with user-defined icons. This sections allows you to enable/disable the system indicator display function.

Setting items	Description
Start/Stop Mark Display	Indicator that shows when capture started and stopped. Sets ON/OFF of this indicator display function.
Trigger Mark Display	Indicator that shows when trigger was generated and capture started. Sets ON/OFF of this indicator display function.
Alarm Mark Display	Indicator that shows when the alarm was generated. Sets ON/OFF of this indicator display function.

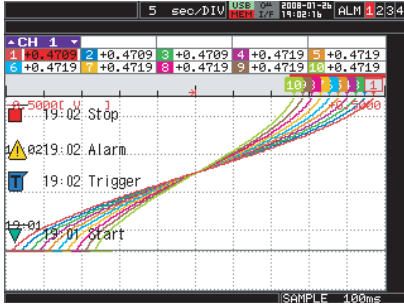

- 19:02 Stop
- ▲ 19:02 Alarm
- T 19:02 Trigger
- ▼ 19:01 Start

CHECKPOINT

The data loss indicator cannot be disabled.

The data loss indicator is displayed the in following cases.

- When power is cut off during data capture, a missing data indicator will be displayed even when power is resumed and data capture is restarted.
- When data loss was acknowledged while you were exchanging the USB memory device during capture operation.

(6) FILE settings

This menu allows you to perform various operations such as file manipulation and screen copying.





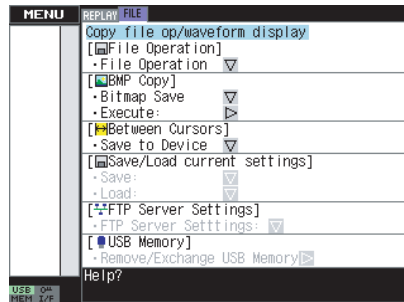
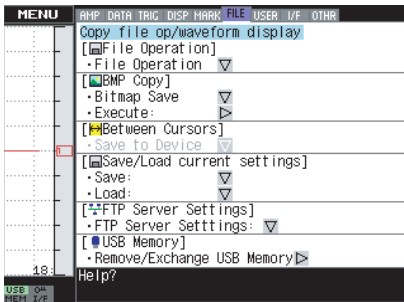







<Settings screen during Free Running and data capture>

<Settings screen during data replay>



Items	Settings 1	Settings 2	Selections available
File Operation	Show properties		▷ Execute
	Create new folder		▷ Execute
	Rename		▷ Execute
	Copy file/folder		▷ Execute
	Delete file/folder		▷ Execute
	File sort order		Alphabetical, Rvse alpha, Oldest firs, Newest first
	View setting		▷ Execute
	Format disk		Quick, Normal
BMP Copy	BMP Save	Folder	MEM, USB1
		Name Type	Auto, User, SN
Between Cursors	Save to Device	Folder	MEM, USB1
		File Type	GBD, CSV
		Name Type	Auto, User, SN
Save/Load current settings	Save	Folder	MEM, USB1
		Name Type	Auto, User, SN
	Load	Folder	MEM, USB1
		File Name	specify file
FTP Server Settings	FTP Server Settings	FTP Server	enter character string
		Username	enter character string
		Password	enter character string
		Port Number	0 to 65535
		PASV Mode	Off, ON
		FTP Server Connection	▷ Execute
USB Memory	Remove/Exchange USB Memory		▷ Execute

(6)-1 File Operation

Key	Description
TIME/DIV	<p>Changes the operation of the file box.</p> <ul style="list-style-type: none">  Show properties Displays details of a file or folder.  Select file/folder Selects files or folders to write data.  Create new folder Creates a new folder.  Create new file Creates a new file.  Rename Changes the file or folder name.  Copy file/folder Copies files or folders.  Select file to copy/delete Selects the file to copy or delete.  Select copy destination and copy . Selects the copy destination and copies.  Delete file/folder Deletes files or folders.  File sort order Changes the order in which files are displayed.  View setting Changes displaying information for files.  Format disk Formats the disk. <p><i>* Details of allowed operation will depend on the operation target.</i></p>
◀▶	<p>Moves between folders.</p> <ul style="list-style-type: none"> ◀ : Move up one folder. ▶ : Move down one folder.
ENTER	Finalizes the operation.
QUIT	Closes the file box.

(6)-2 BMP Copy

Saves the Waveform/Digital/Bar Graph screen as BMP data files.

Setting items	Description						
Folder	Specifies the destination where a BMP data file is saved.						
	<table border="1"> <tr> <td>MEM</td> <td>Saves the file in the internal Flash memory. Folders can be specified in File Operation settings.</td> </tr> <tr> <td>USB1</td> <td>Saves the file in the USB memory. Folders can be specified in FileOperation settings.ÅB</td> </tr> </table>	MEM	Saves the file in the internal Flash memory. Folders can be specified in File Operation settings.	USB1	Saves the file in the USB memory. Folders can be specified in FileOperation settings.ÅB		
MEM	Saves the file in the internal Flash memory. Folders can be specified in File Operation settings.						
USB1	Saves the file in the USB memory. Folders can be specified in FileOperation settings.ÅB						
File Name	Sets the file name when User is set for Name Type.						
Name Type	Specifies how files are named.						
	<table border="1"> <tr> <td>Auto</td> <td>A file name is created automatically.</td> </tr> <tr> <td>User</td> <td>Specifies a user-defined name.</td> </tr> <tr> <td>SN</td> <td>Creates a file by appending a serial number to the file name.</td> </tr> </table>	Auto	A file name is created automatically.	User	Specifies a user-defined name.	SN	Creates a file by appending a serial number to the file name.
Auto	A file name is created automatically.						
User	Specifies a user-defined name.						
SN	Creates a file by appending a serial number to the file name.						

Procedure

Set the BMP save destination. => Pressing the ENTER key in Execute saves the file to the specified location.

⚠ CAUTION

- Menu-related BMP files cannot be saved.

(6)-3 Between Cursors

This function allows you to save data between cursors, while replaying captured data.

Setting items	Description	
Folder	Specifies the location where data between cursors is saved.	
	MEM	Saves data in the internal Flash memory. Folders can be specified in File Operation settings.
	USB1	Saves data in the USB memory. Folders can be specified in FileOperation settings.
File Name	Sets the file name when User is set for Name Type.	
File Type	Specifies the file format used to save a file.	
	GBD	Creates data files in a proprietary binary format. * Data cannot be altered.
	CSV	Creates data files in text format. * Cannot be replayed in MT100.
Name Type	Specifies how files are named.	
	Auto	A file name is created automatically.
	User	Specifies a user-defined name.
	SN	Creates a file by appending a serial number to the file name.

 **CHECKPOINT**

- Data save between cursors can only be performed after you set the saving range with the cursor, following captured data replay.
For details on data replay, see page 3-68.

 **CAUTION**

- This menu is only enabled while data is replayed.

(6)-4 Save/Load Current Settings

This section allows you to save or load MT100's condition settings.

Setting items	Description	
Folder	Specifies the location where condition settings are saved (or load source).	
	MEM	Saves (loads) settings in the internal Flash memory. Folders can be specified in File Operation settings.
	USB1	Saves (loads) settings in the USB memory. Folders can be specified in FileOperation settings.
File Name	Save	Sets the file name when User is set for Name Type.
	Load	Specifies the settings file to load (file extension is CND).
Name Type (save only)	Specifies how files are named.	
	Auto	A file name is created automatically.
	User	Specifies a user-defined name.
	SN	Creates a file by appending a serial number to the file name.

 **CAUTION**

- This function is only enabled during Free Running.

(6)-5 FTP Server Settings

This section allows you to make settings to establish a connection to the FTP server in the network. These settings must be made to allow measurement data to be backed up periodically to the FTP server. In such cases, specify FTP in DATA menu=>Backup Settings=>Backup Destination (see page 3-23).

Setting items	Description
(1) FTP Server	Sets the domain name of the FTP server.
(2) Username	Sets the login name for the FTP server.
(3) Password	Sets the login password for the FTP server.
(4) Port Number	Sets the port number of the FTP server.
(5) PASV Mode	Sets ON/OFF of passive mode.
	ON Select ON to establish connection to an external FTP server in a firewall-enabled environment.
	Off Select Off to establish connection to an FTP server in a general network environment.
(6) FTP Server Connection	Conduct a test to confirm connection to the configured FTP server. Connection status message is displayed when a connection test is performed. *The following message is displayed when the connection test resulted with an OK status.
	<div style="border: 1px solid black; padding: 2px; display: inline-block;">Connection established</div> <div style="border: 1px solid black; padding: 2px; display: inline-block;">[ENTER]Apply</div>

CAUTION

- This menu is only enabled during Free Running.
-

(6)-6 USB Memory

This function is used when you need to remove or exchange USB memory devices. Follow the directions displayed in the message windows to remove or exchange the USB memory device (see page 3-47).

CAUTION

- This function is only enabled during Free Running and data capturing.
-

(7) User settings

This menu is used to store setting conditions for each user. By switching between users, these setting conditions can easily be read out.

This menu is used to specify the user name and switches user setting conditions.

You can specify that the user is a Guest, User 1 or User 2.

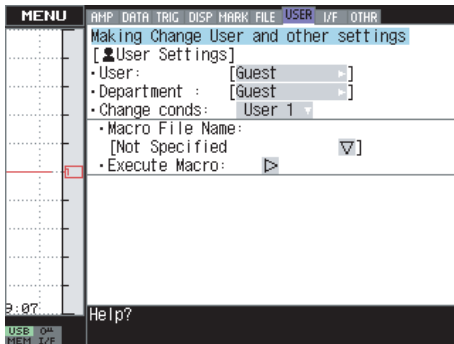

Items	Settings 1	Settings 2	Selections available
User Settings	User		When set to User: enter text string
	Department name		When set to User: enter text string
	Change Conds		Guest, User 1, User 2
Macro File Name	Folder		MEM, USB1
	File Name		specify file name
Execute Macro			▶ Execute

(7)-1 User Settings

Setting items	Description
User	Specifies the user name. You cannot set this item when Guest is selected.
Department name	Specifies the department name. You cannot set this item when Guest is selected.
Change Conds	Switches between Guest, User 1, and User 2. Since setting conditions are stored for each user, they can be called up easily by simply switching the user.

(7)-2 About the Macro

Interface commands for MT100 can be described in a text file and read in. MT100 will operate as described in this file.

<Macro operation flow>

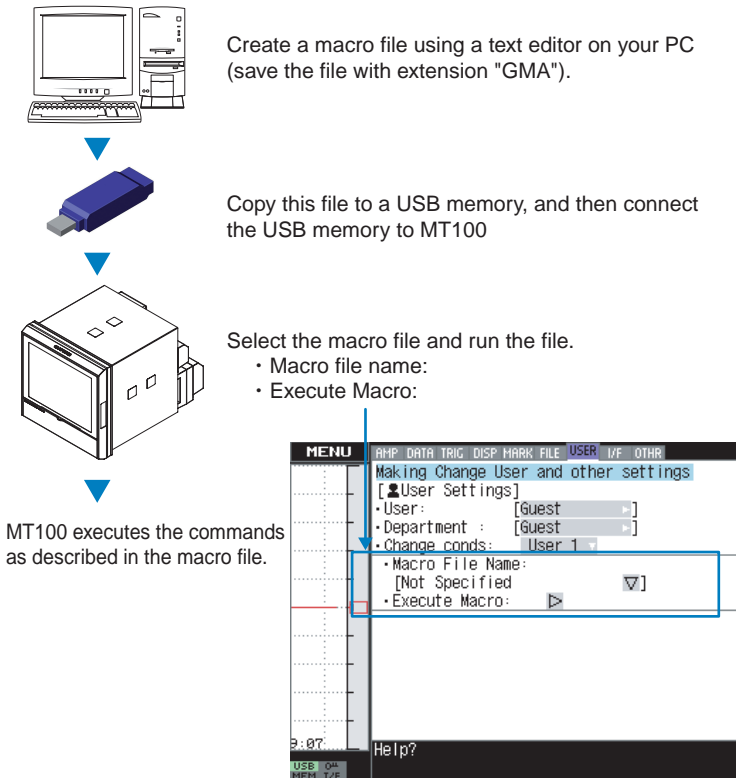

Macro description example (file name: xxx.GMA)

```

// ***** MT100 Macro File *****
// Input Setting
:AMP:CH1:INP TEMP:RANG TCT // CH1 Temperature
:AMP:CH2:INP DC:RANG 500MV // CH2 DC 500mV
:AMP:CH3:INP RH // CH3 Humidity

// Span Setting
:SPAN:CH1:SET 100.0,"C" // CH1 0-100C

// Annotation Setting
:ANN:CH1 "Batt. Temp" // CH1 Annotation

// Sampling Setting
:DATA:SAMP 1S // Sampling 1sec
    
```

CAUTION

Refer to the "Interface Command Table" for details on commands supported by MT100 on a separate sheet. The "Interface Command Table" is included in the CD. Supported commands are limited to those relative to MT100 settings. Read in commands cannot be used.

(8) Interface settings

This menu is used to specify conditions for PC connection.

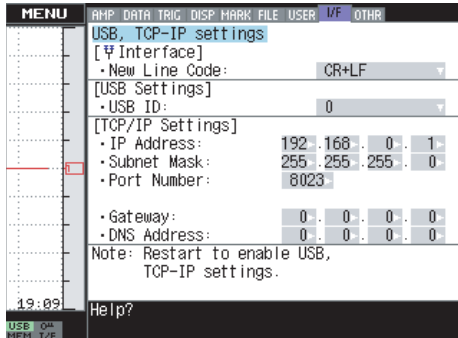

Items	Settings 1	Settings 2	Selections available
Interface	New Line Code		CR+LF, LF, CR
USB Settings	USB ID		0 to 9
TCP/IP Settings	IP Address		0 to 255 . 0 to 255 . 0 to 255 . 0 to 255
	Subnet Mask		0 to 255 . 0 to 255 . 0 to 255 . 0 to 255
	Port Number		1024 to 65535
	Gateway		0 to 255 . 0 to 255 . 0 to 255 . 0 to 255
	DNS Address		0 to 255 . 0 to 255 . 0 to 255 . 0 to 255

(8)-1 Interface

This section allows you to set the new line code to use when controlling the PC connection with the interface commands.

Setting items	Description	
New Line Code	CR+LF	Starts a newline with CR+LF code.
	LF	Starts a new line with LF code.
	CR	Starts a new line with CR code.

(8)-2 USB Settings

Sets the USB ID number of MT100.

Specify a number from 0 to 9.

When multiple devices are controlled from a single PC, make sure each device is assigned to a different ID number.

! CAUTION

You must restart MT100 after any change is made to a setting value. Changes are applied upon restart.

(8)-3 TCP/IP Settings

Sets values to establish an Ethernet connection.

Setting items	Description
IP Address	Sets the IP address of MT100 (0 to 255 . 0 to 255 . 0 to 255 . 0 to 255).
Subnet Mask	Sets the IP subnet mask of MT100 (0 to 255 . 0 to 255 . 0 to 255 . 0 to 255).
Port Number	Sets the port number of MT100 (1024 to 65535).
Gateway	Sets the gateway of MT100 (0 to 255 . 0 to 255 . 0 to 255 . 0 to 255).
DNS Address	Sets the DNS address of MT100 (0 to 255 . 0 to 255 . 0 to 255 . 0 to 255).

! CAUTION

You must restart MT100 after any change is made to a setting value. Changes are applied upon restart.

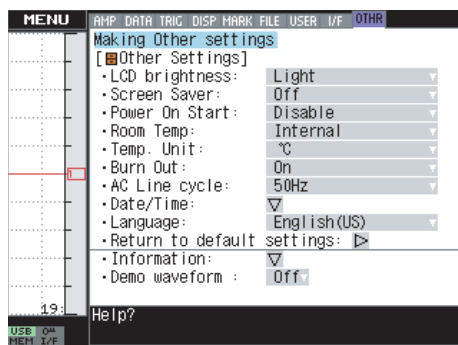

(9) OTHR settings

Other miscellaneous settings are made here.



Items	Settings 1	Settings 2	Selections available	
OTHR settings	LCD brightness		Light, Medium, Dark	
	Screen Saver		Off, 10, 30 (sec), 1, 2, 5, 10, 30, 60 (min)	
	Power On Start		Disable, Enable	
	Room Temp.		Internal, External	
	Temp. Unit		°C, °F	
	Burn Out		On, Off	
	AC Line cycle		50, 60 Hz	
	Date/Time	Date/Time	Date/Time	Date, time settings
		Internet Time		Off, On
		NTP Server		enter text string
		Time Zone		-12:00 to +13:00 (unit: hours)
		Synchronized Time		00:00 to 23:59
		Adjust Mode		Step, Slew
	Language			Japanese, English (US), English (UK), French, German, Chinese, Korean
Return to default settings			▷ Execute	
Information			▽ Display	
Demo Waveform Mode			Off, On	

(9)-1 OTHR settings

Setting items	Description
LCD brightness	Sets the brightness of the LCD backlight. Available selections are Light, Medium, and Dark.
Screen Saver	Automatically turns off the display if the MT100 is not operated within a specified interval. Available selections are Off, 10, 30 s, 1, 2, 5, 10, 30, 60 min. Turning off the display frequently using the Screen Saver function allows longer lifetime of the LCD screen.
Power On Start	Sets the feature which initiates measurement as soon as the MT100 is turned on.
	Disable Disables the Power On Start function.
	Enable Enables the Power On Start function.
Room Temp.	This parameter enables room temperature compensation settings when thermocouples are used.
	Internal The MT100's room temperature compensation settings are used (usually, use this parameter).
	External This parameter is set to enable room temperature compensation settings in external devices.
Temp. Unit	Toggles the temperature unit between °C and °F.
	°C Celsius
	°F Fahrenheit (the scaling function is compulsorily enabled)
Burn Out	Sets a feature which checks sensor burnout in a thermocouple.
	Off Disables burnout check.
	On Enables periodic burnout check.  CAUTION During a burnout check, voltage is applied to the MT100.† Therefore, set Burn Out to Off when MT100 is connected in parallel with other devices to avoid any effect from these voltages.
AC Line cycle	Selects the frequency of the AC line used.
	50Hz For areas using line frequency of 50 Hz.
	60Hz For areas using line frequency of 60 Hz.
	 CAUTION This setting specifies the frequency in which noise can be eliminated with the digital filter function. Note that the digital filter is enabled when the sampling frequency is set to 500 ms or above.
Date/Time	This parameter sets the date and time.
	Date/Time Sets the internal clock of the device. Enter the correct date and time.
	Internet Time This setting is used to adjust the internal clock via the network. *For details, see the next page.
Language	Sets the MT100's display language. Available selections are Japanese, English (US), English (UK), French, German, Chinese, and Korean.
Return to default settings	Returns all the settings to factory default.

Internet Time Settings

The MT100 is equipped with a feature that allows the internal clock to be synchronized to a time server via Ethernet.

This section allows you to make settings to use this function.

Date/Time:	
Internet Time:	On ▾
NTP Server:	[ntp.jst.mfeed.ad.jp ▶]
Time Zone:	GMT+09:00 ▾
Synchronized Time :	00:00
Adjust Mode:	Step ▾
Connection Test:	▶
<input type="button" value="OK"/> <input type="button" value="Cancel"/>	

Setting items	Description	
(1) Internet Time	Selects whether to adjust the internal clock using the time server.	
	Off Time server is not used. Time adjustment will not be performed.	
	On Time is adjusted using the time server.	
(2) NTP Server	Enter the domain name of the time server to be used.	
(3) Time Zone	Sets the time zone where MT100 is used. (Japan: +9:00)	
(4) Synchronized Time	Sets the time when MT100 is synchronized with the time server.	
	The internal clock will start synchronization upon the set time using the method selected in Adjust Mode.	
(5) Adjust Mode	Sets the method to synchronize the internal clock to the time server.	
	Step Sets the internal clock to the time server at Synchronized Time.	
	Slew Gradually synchronizes the internal clock to the time server. Therefore, the internal clock will not be set instantaneously at Synchronized Time. Amount of adjustment is approximately 43 s/day (approx. 10 ms in 20 seconds).	
 CAUTION Synchronization is not conducted when the difference between the internal clock and time server is less than 500 ms.		
(6) Connection Test	Conducts a test to confirm connection to the time server. A message is displayed when a connection test is performed. If a connection cannot be established, check all settings and perform the connection test again. *The following message is displayed when the connection test resulted with an OK status.	
	<table border="1" style="margin: auto;"> <tr> <td>Connection established</td> </tr> <tr> <td>[ENTER]Apply</td> </tr> </table>	Connection established
Connection established		
[ENTER]Apply		

(10) Data replay menu

Data replay menus are displayed by pressing the MENU key during replay.

* For details on how to replay data, see page 3-68.

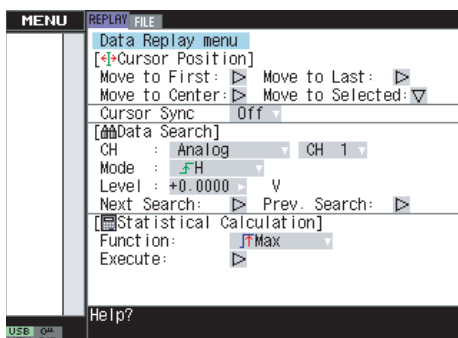

Items	Settings 1	Settings 2	Selections available	
Cursor Position	Move to First		▷ Execute	
	Move to Center		▷ Execute	
	Move to Last		▷ Execute	
	Move to Selected	Method		Position, Time
		Move to		When Position is selected Relative time When Time is selected Date, time
Cursor Sync		Off, ON		
Data Search	CH		Analog, Pulse (Logic), Alarm	
	CH: Analog	CH	CH1 to CH10	
		Mode	H, L	
		Level	set numeric value	
	CH: Pulse	CH	Pulse1 to Pulse4	
		Mode	H, L	
		Level	set numeric value	
	CH: Logic	CH	Logic1 to Logic4	
		Mode	H, L	
	CH: Alarm	CH	Alarm1 to Alarm4	
Mode		Both, H, L		
Next Search		▷ Execute		
Prev. Search		▷ Execute		
Statistical Calculation	Function		Off, Average, Max, Min, Peak, RMS	
	Execute		▷ Execute	

(10)-1 Cursor Position

This function allows the cursor displayed during captured data replay to move to a specified location. The following settings can be made.

Setting items	Description	
Move to First	Moves the cursor to the beginning of data.	
Move to Last	Moves the cursor to the end of data.	
Move to Center	Move the cursor to the center of data.	
Move to Selected	Specifies the cursor position to be moved to.	
	Position	Moves the cursor by specifying relative time.
	Time	Moves the cursor by specifying date and time.
Cursor Sync	Allows synchronization of two cursors when moved. Cursor A is always the fulcrum.	
	Off	Moves the specified cursor (only one).
	On	Moves two cursor in sync.



- When Cursor Sync is set to OFF, the currently selected cursor will move. See page 3-6 for details on how to select cursors.
- When Cursor Sync is set to ON, both cursors will move.

(10)-2 Data Search

This function allows you to perform a search within the captured data using the specified method. The following methods can be specified.

Setting items	Description	
CH	Selects the channel you want to search.	
	Analog	Selects analog channels to be searched.
	Pulse	Selects pulse channels to be searched.
	Logic	Selects logic channels to be searched.
	Alarm	Selects alarm channels to be searched.
<When Analog is selected>		
CH	Selects the analog channel number to be searched.	
Mode	Selects the mode used for search.	
	H	Searches the location where the specified channel's signal rose above the specified level.
	L	Searches the location where the specified channel's signal fell below the specified level.
Level	Sets the criteria level to perform a search.	
<When Pulse is selected>		
CH	Selects the pulse channel number to be searched.	
Mode	Selects the mode used for search.	
	H	Searches the location where the specified channel's signal rose above the specified level.
	L	Searches the location where the specified channel's signal fell below the specified level.
Level	Sets the criteria level to perform a search.	
<When Logic is selected>		
CH	Selects the logic channel number to be searched.	
Mode	Selects the mode used for search.	
	H	Searches the location where the specified channel's signal changed from L to H.
	L	Searches the location where the specified channel's signal changed from H to L.
<When Alarm is selected>		
CH	Selects the alarm channel number to be searched.	
Mode	Selects the mode used for search.	
	Both	Searches the location where the specified alarm was generated or cancelled.
	H	Searches the location where the specified alarm was generated.
	L	Searches the location where the specified alarm was cancelled.

(10)-3 Statistical Calculation between cursors

Statistical calculation is performed on the replay data between two cursors.

Setting items	Description	
Function	Off	Calculation is not performed.
	Average	Displays the average value of data between two cursors.
	Max	Displays the maximum value of data between two cursors.
	Min	Displays the minimum value of data between two cursors.
	Peak	Displays the peak value of data between two cursors.
	RMS	Displays the RMS of data between two cursors. The following formula is used. $R.M.S = \sqrt{D^2/n}$ * <i>D</i> : data <i>n</i> : number of data

<Displayed calculation results>

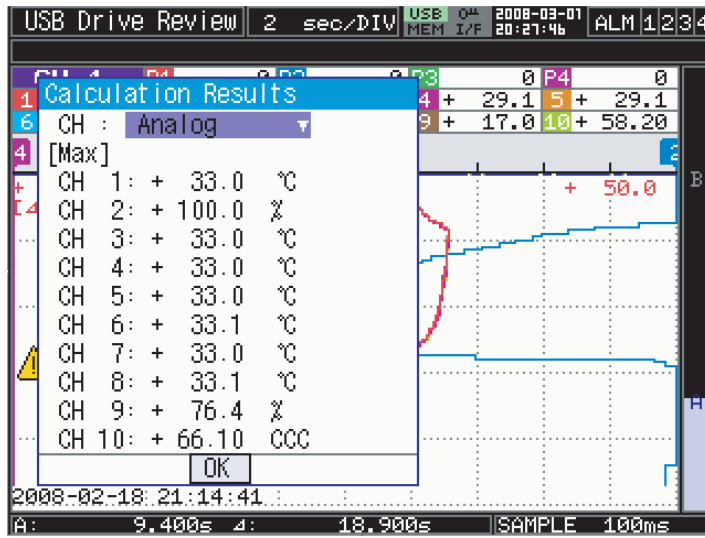

3.5 Key Lock Function

The key lock function allows you to lock all keys by entering a password.

You can set the password to avoid users other than the administrator from operating the keys.

* No password is set at factory default.

Setting the password

(1) Press the \triangleleft , \triangleright , and ENTER keys at the same time.

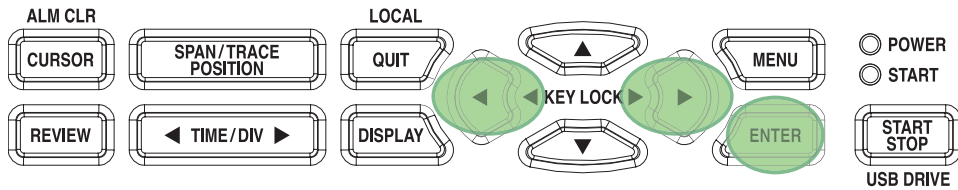

(2) The following menu is displayed. Enter a password.

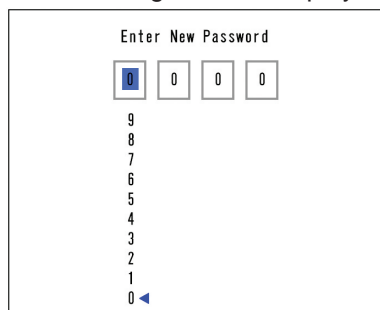

Use the \triangleleft , \triangleright , \triangle , ∇ keys to select numbers. Press the ENTER key to confirm the password. Specifying 0000 will disable password operation.

Setting the key lock

Hold down the \triangleleft and \triangleright keystogether for at least two seconds.

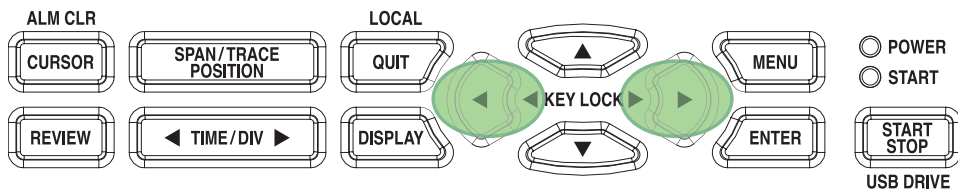

When all keys are locked, the indicator  will change to .

Canceling the key lock function

(1) Hold down the \triangleleft and \triangleright keys together for at least two seconds.

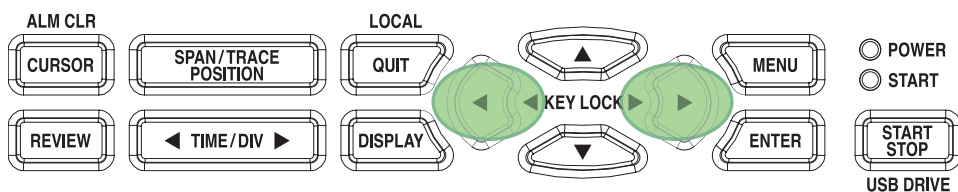

(2) The following menu is displayed. Enter your password.

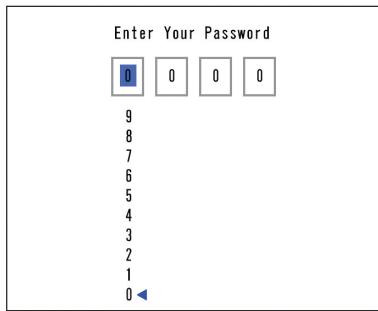

Use the ◀, ▶, ▲, ▼ keys to select numbers. Press the ENTER key to confirm the password.

⚠ CAUTION

- If you forget your password, please contact us to acquire the master password.
 - The Enter New Password screen will not be displayed when no password has been set.
-

3.6 Exchanging USB Memory Device During Capture

You can exchange USB memory devices while capturing data into them. Follow the procedures below to exchange the memory device.

(1) Press the MENU key to open the FILE menu.

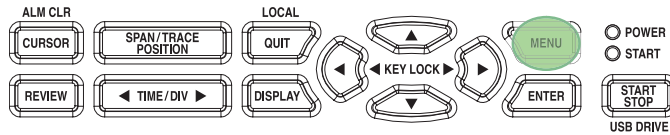
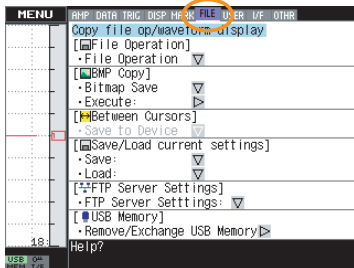

(2) Move the cursor to Remove/Exchange USB Memory and press the ENTER key.

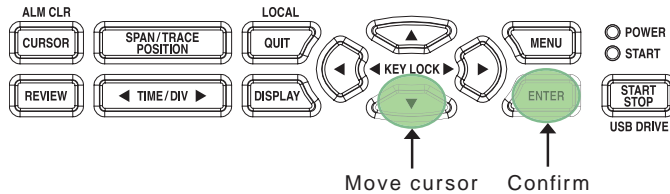
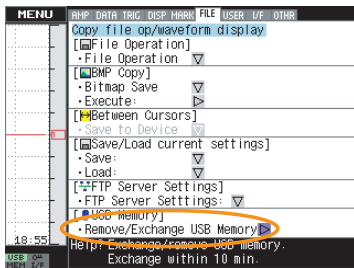

(3) The following message is displayed.† Remove the USB memory device from the MT100.

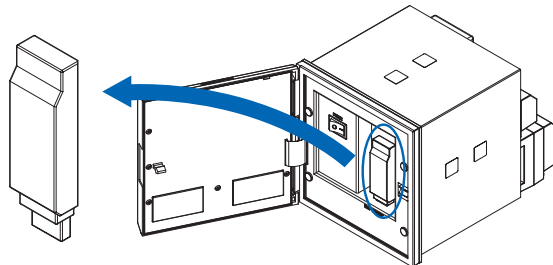
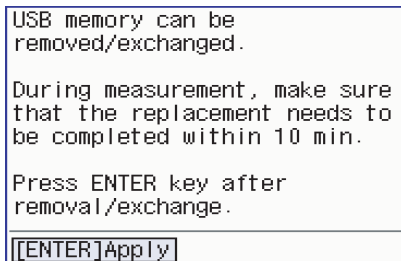

(4) Insert a new USB memory device.

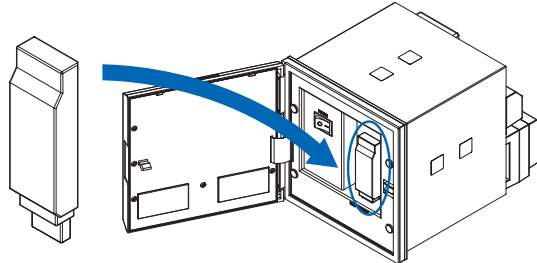
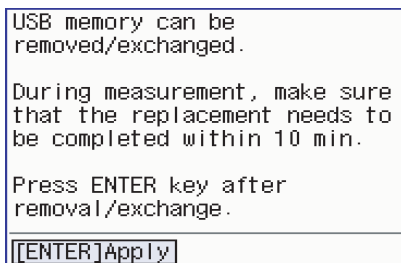

(5) Press the ENTER key.

 **CHECKPOINT**

"_CHG" and a number will be appended to the file name each time you exchange a USB memory device.

Ex) When data is captured to file "TEST.GBD":

First USB memory device: TEST.GBD

Second USB memory device: TEST_CHG1.GBD

Third USB memory device: TEST_CHG2.GBD

 **CAUTION**

The exchange procedure must be conducted within ten minutes.

Data will be lost when ten minutes have elapsed.

The data loss indicator will be displayed when any data loss is acknowledged.

3.7 WEB Server Function

This function allows operating and monitoring MT100 via a Web browser.

• Supported Web browsers

- Microsoft Internet Explorer 6.0 or later
- Netscape 6.2 or later
- Firefox 1.5 or later
- Opera 9.0 or later

• Available functions using a Web browser

- Operating MT100
- Monitoring MT100 display screen
- Enlarging MT100 display screen
- Linking to FTP
- Linking to our Web site

• Setting the URL

The URL (Uniform Resource Locator) must be correctly set according to your network environment. Follow the procedure below to access the MT100.

<http://IP address/index.html>

- http Protocol to access the server.
HTTP (Hyper Text Transfer Protocol)
- IP address Type in the IP address of the MT100 to monitor.
- index.html File name. This is fixed to index.html.

• Procedure

1. Open the Web browser.
2. Type in the URL (<http://IP address/index.html>) in the address input field.

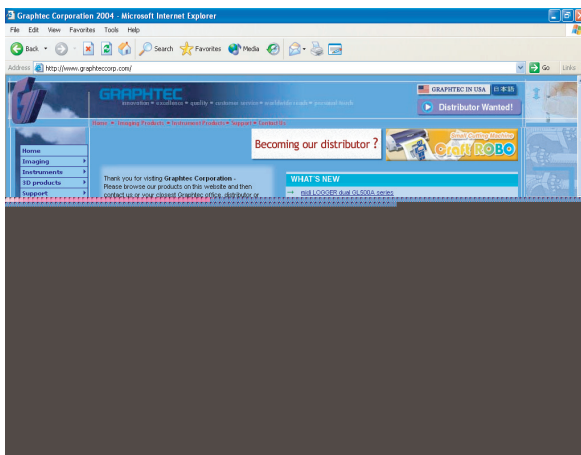

• Zoom

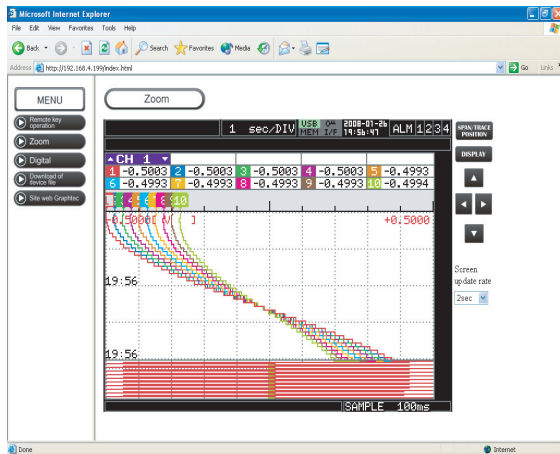

- DISPLAY Switches the display mode.
Press this key to switch among Waveform + Digital, Expanded Waveform, and Digital screens.
- SPAN/TRACE/POSITION Switches the display in the digital display area.
Press this key to switch among MONITOR, SPAN, POSITION, and TRACE.
- ◀▷ ▲▼ Cursor keys
- Screen update speed Specifies the speed in which the screen is updated.
Available update speeds are 2, 5, and 10 seconds.

• Digital

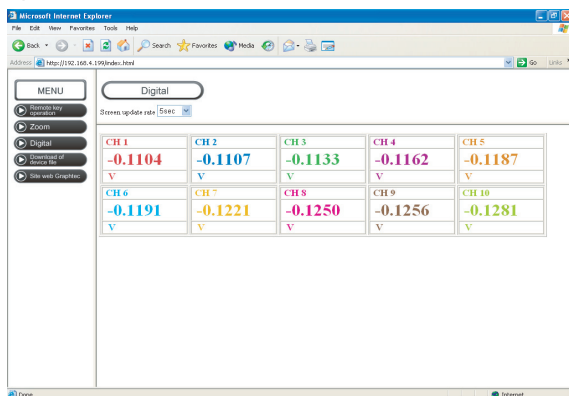

- Screen update speed Specifies the speed in which the screen is updated.
Available update speeds are 2, 5, and 10 seconds.

• **Download of device file**

Allows memory data from MT100 and data in USB memory to be downloaded to your PC.

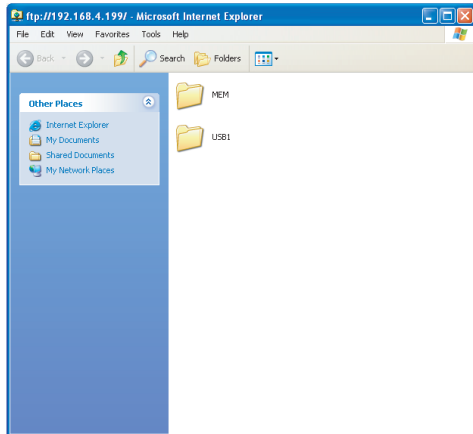

• **About the FTP server function**

When an Internet Explorer FTP connection is used, login is automatically performed using an anonymous account and the files become read-only files.

The following operations cannot be performed for read-only files:

- Upload file
- Delete file/folder
- Create file/folder
- Change file name/folder name

To enable data to be written to the MT100, the login account name must be changed. please use the following table as a guide.

Account name	Password	Restrictions
MT100	None	None
mt100	None	None
Anonymous	Any	Read-only

The following procedure is used to change the Internet Explorer login account. Go to the File menu and select Login As... to open the login As dialog box.



Enter the account name in the User Name box. leave the Password box blank. Finally, click the "Login" button.

3.8 Setting Examples

(Ex.1) Measuring temperature with thermocouples for all channels

The following procedure shows how to measure temperature using thermocouples for all channels.

(1) Press the MENU key to open the AMP menu.

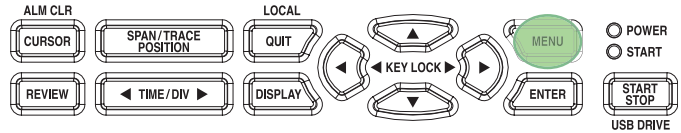
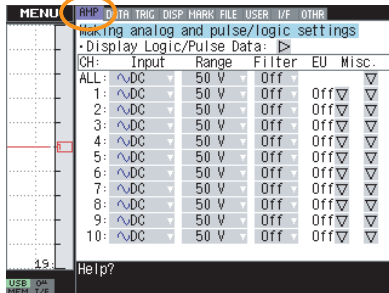

(2) Use the ∇ key to move the cursor to the section where ALL and Input intersect.

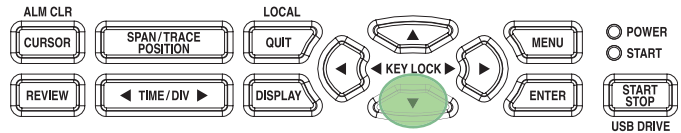
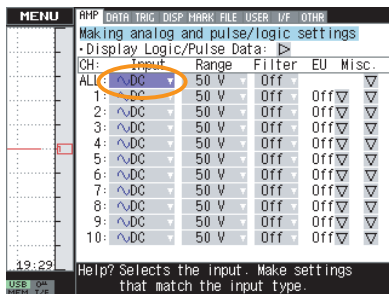

(3) Press the ENTER key and select TEMP.

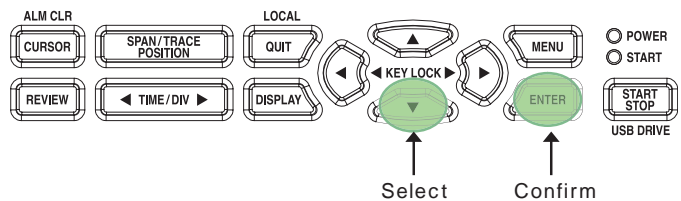
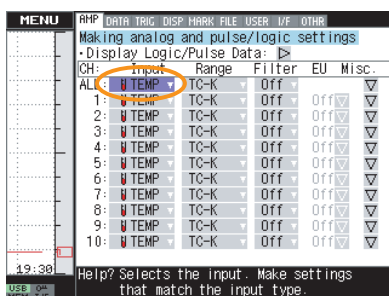

(4) Press the ▷ key to move to the section where ALL and Range intersect.

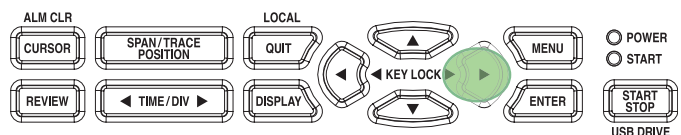
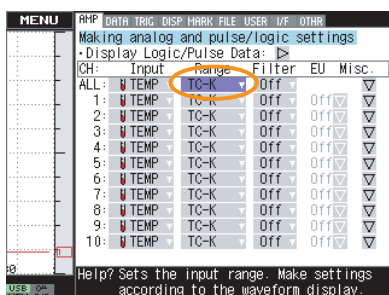

(5) Press the ENTER key and select the thermocouple type.

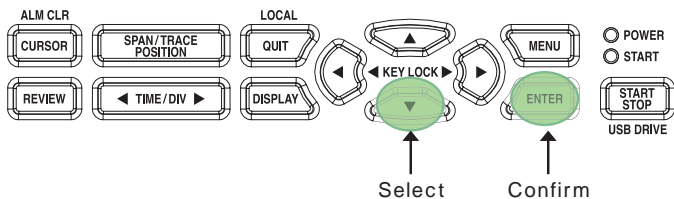
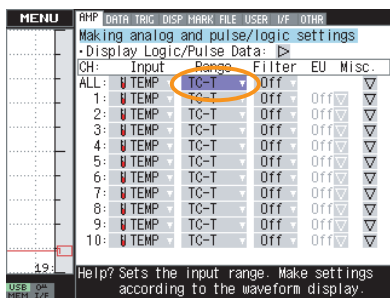

(6) Press the MENU key to open the DATA menu.

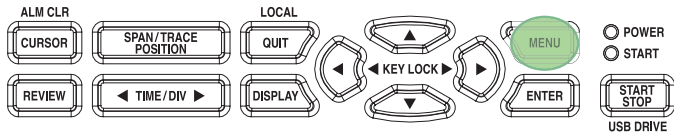
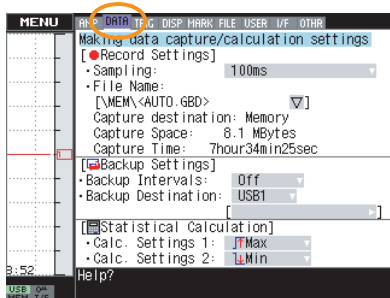

(7) Use the ▾ key to move the cursor to Sampling.

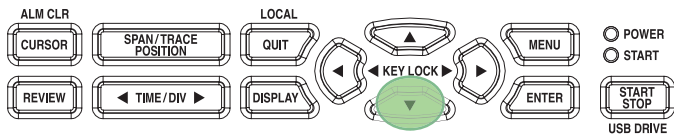
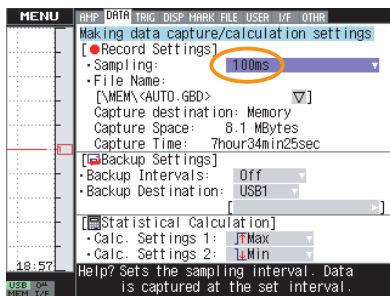

(8) Press the ENTER key and set Sampling Interval to 1 s.

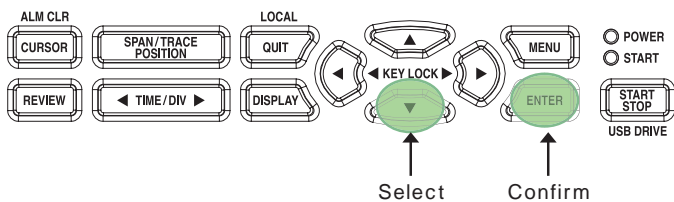
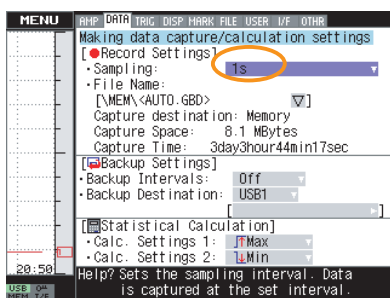

* For temperature measurement, the sampling interval should be set to a value above 1 s to enable the digital filter.

(9) Configuration completed.
Press START key to begin measurement.

(Ex.2) Measuring humidity with humidity sensor B-530

The following procedure shows how to measure temperature using the humidity sensor B-530.

(1) Press the MENU key to open the AMP menu.

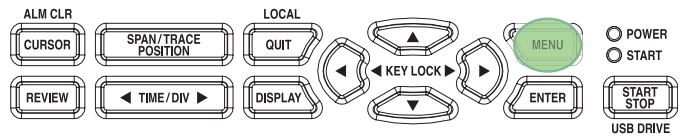
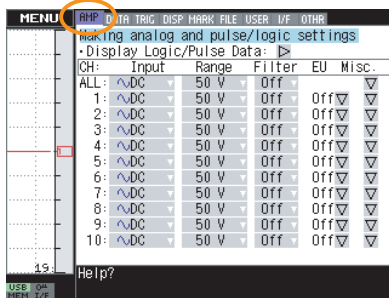

(2) Use the ∇ key to move the cursor to the section where Input intersect.

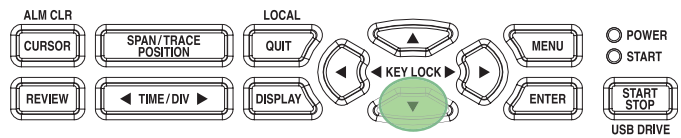
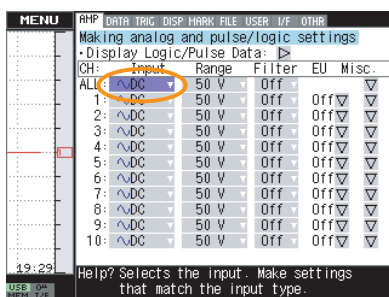

(3) Press the ENTER key and select RH.

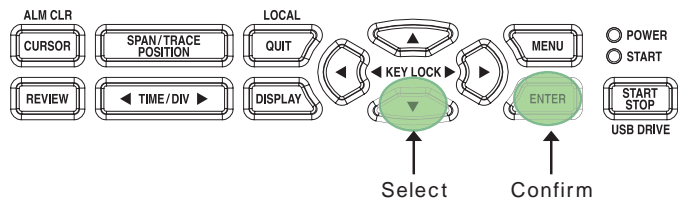
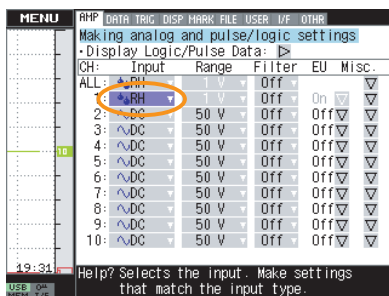

(4) Configuration completed.
Press START key to begin measurement.

(Ex.3) Setting the USB memory device as the destination for data capture

The following procedure shows how to set the USB memory device as the location to capture measurement data. This setting allows data to be captured into a file automatically created in the USB memory device.

(1) Press the MENU key to open the DATA menu.

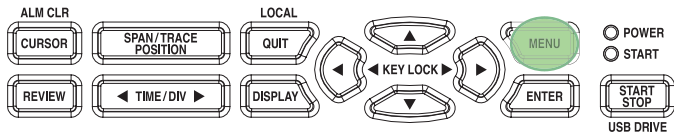
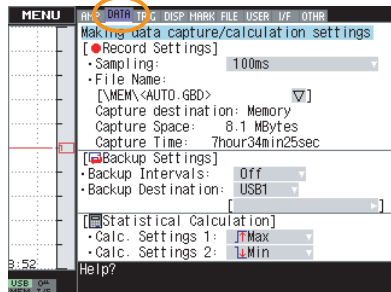

(2) Use the ∇ key to move the cursor to File Name and press the ENTER key.

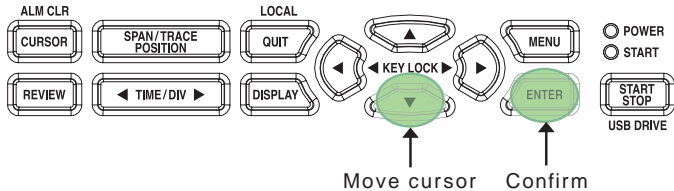
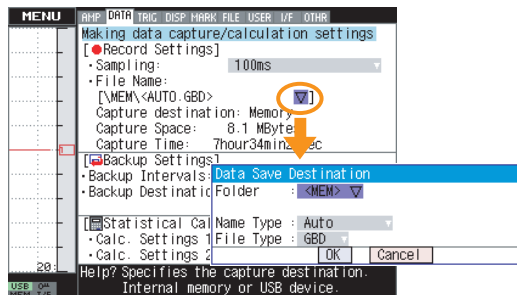

(3) Press the ENTER key in Folder.

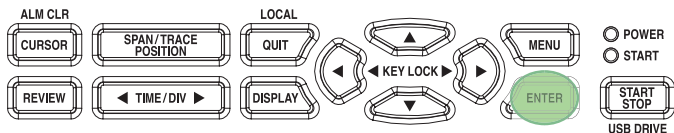
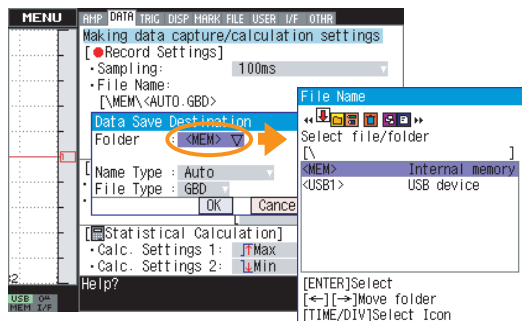

(4) Use the ∇ key to move the cursor to USB1 and press the ENTER key.

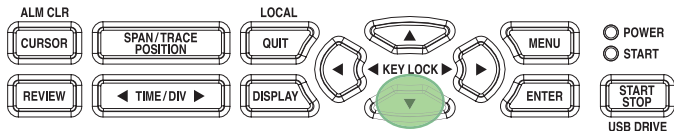
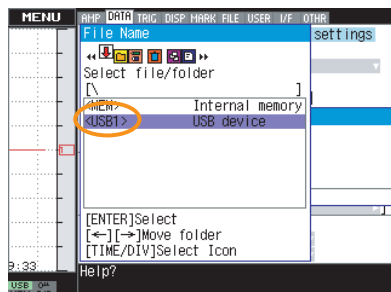

(5) Use the ∇ key to move the cursor to OK and press the ENTER key.

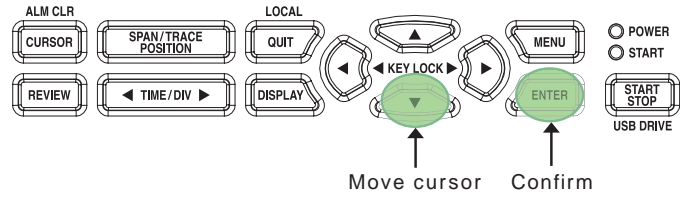
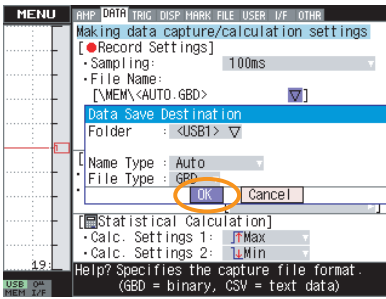

(Ex.4) Creating a folder for data capture

The following procedure shows how to create a folder in the memory device to capture data. This setting allows data to be captured into a file automatically created in a folder inside the internal Flash memory.

(1) Press the MENU key to open the DATA menu.

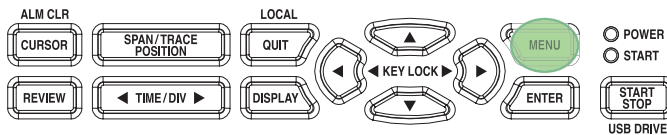
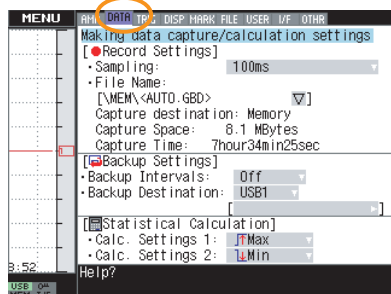

(2) Use the ∇ key to move the cursor to File Name and press the ENTER key.

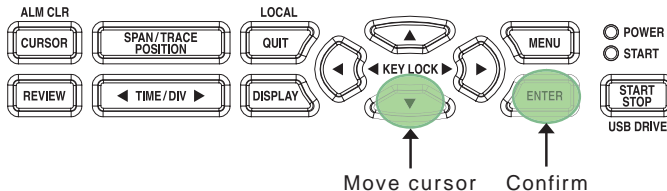
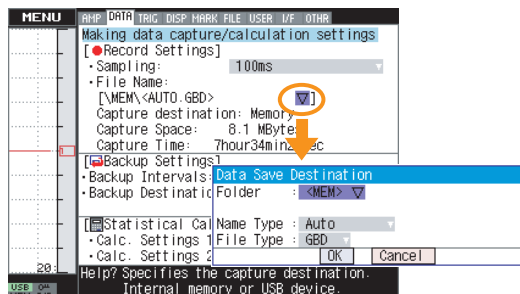

(3) Press the ENTER key in Folder.

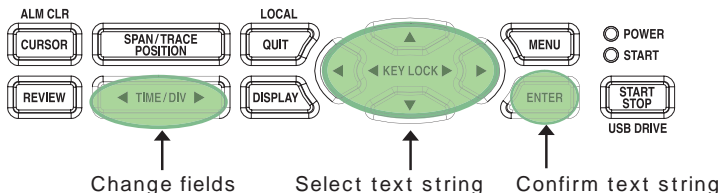
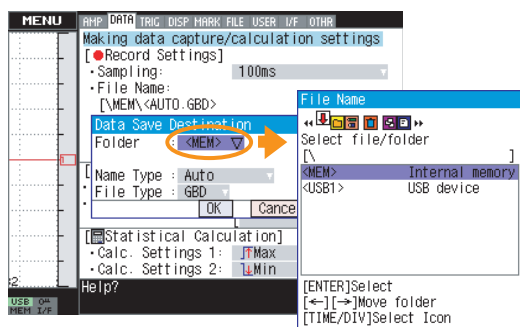

(4) Use the TIME/DIV key to select Create new folder.

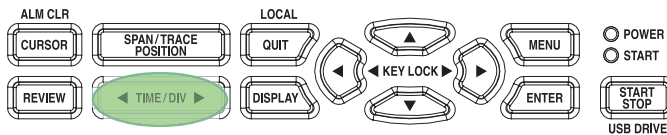
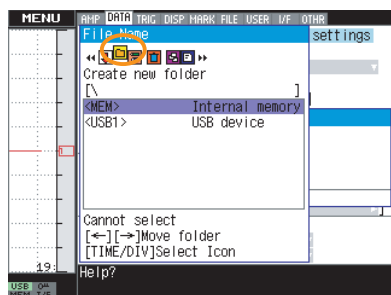

(5) Press the \triangleright key to display the contents of the device.

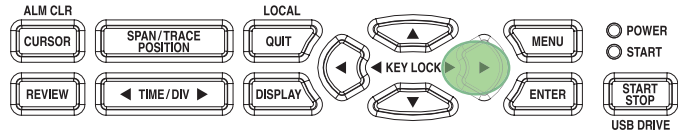
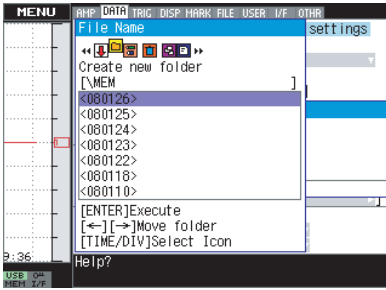

(6) Press the ENTER key.

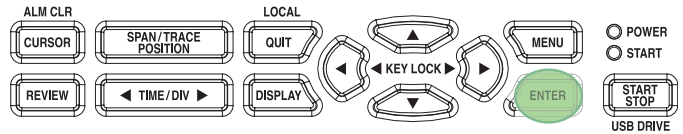
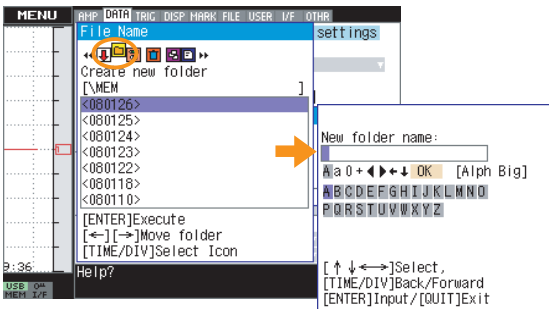

(7) A text box is displayed. Enter a name for the folder to be created.

Select characters using the \triangleleft , \triangleright , \triangleup , \triangledown , TIME/DIV keys. Confirm the entered text string with the ENTER key. After confirming the text string, move the cursor to OK and press the ENTER key.

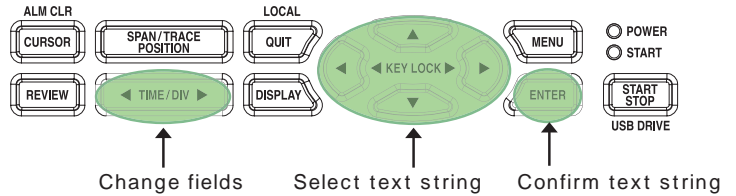
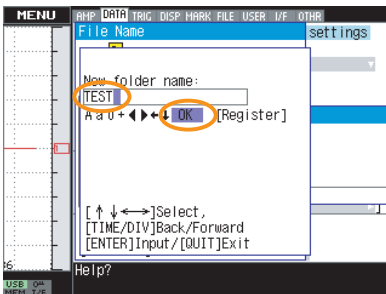

(8) Use the TIME/DIV key to move to Select file/folder.

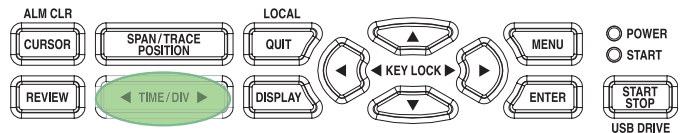
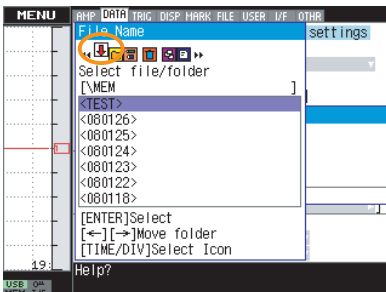

(9) Select the folder you have just created and press the ENTER key.

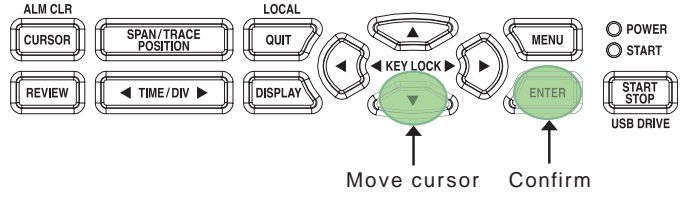
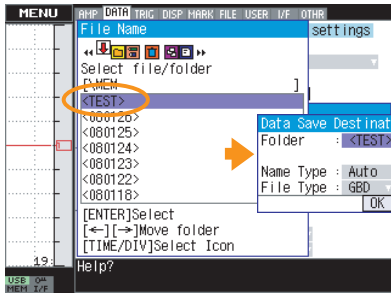

(10) Use the ∇ key to move to OK and press the ENTER key.

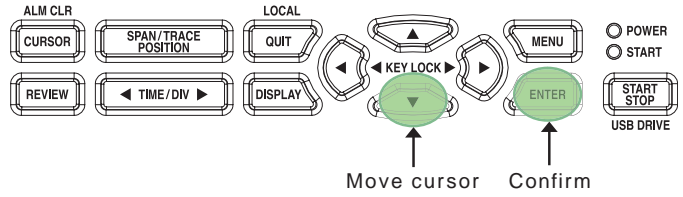
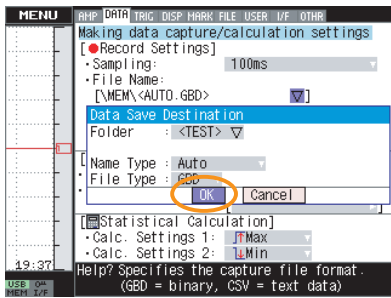

(Ex.5) Backing up data to the FTP server

The following procedure shows how to periodically back up the captured data to the FTP server.

(1) Press the MENU key to open the FILE menu.

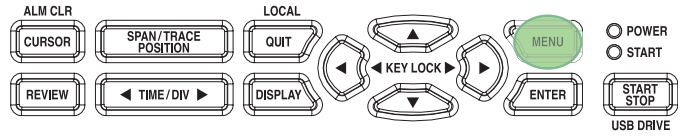
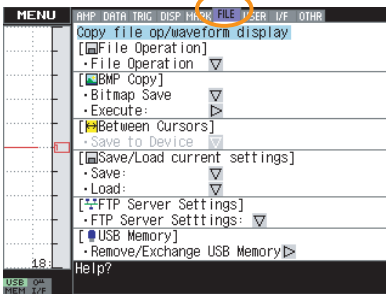

(2) Make settings for the FTP server.
See 3-35 for details.

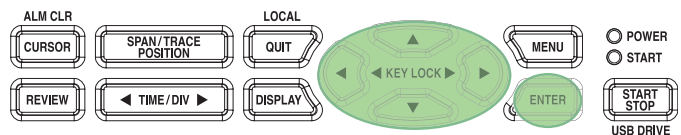
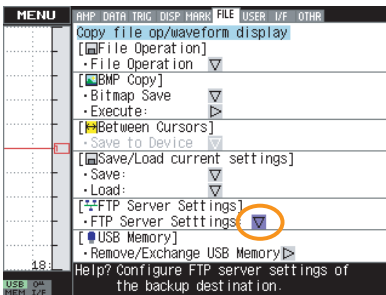

(3) Press the MENU key to open the DATA menu.

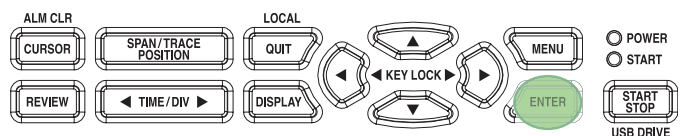
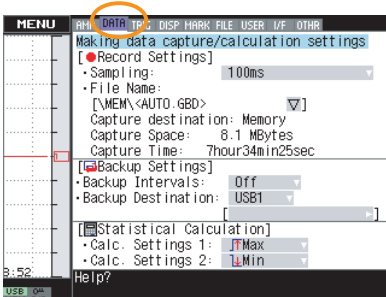

(4) Specify Backup Intervals.

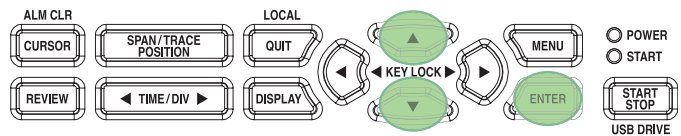
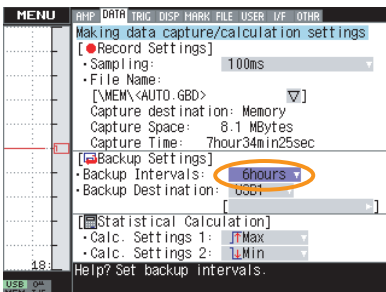

(5) Select FTP as the Backup Destination.

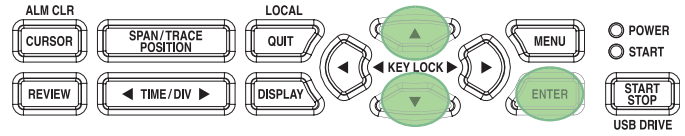
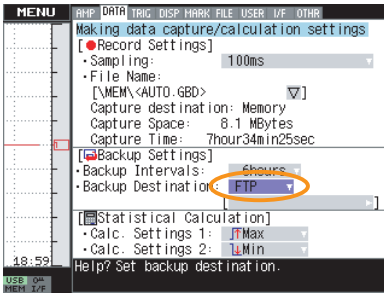

(6) Specify a folder where data should be saved.
A text box is displayed. Select a folder to back up data.

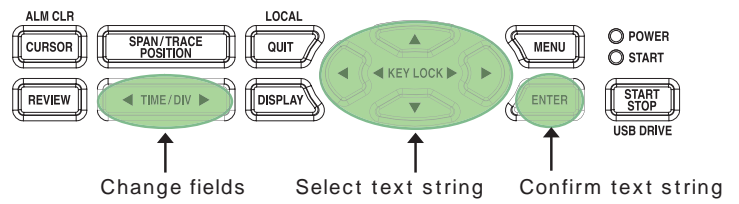
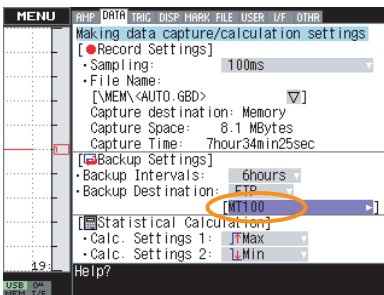

(Ex.6) Capturing data on a specified day every week

The following procedure shows how to capture data only on a specified day each week. This setting allows you to capture data every Monday for one hour from 10 o'clock.

(1) Press the MENU key to open the TRIG menu.

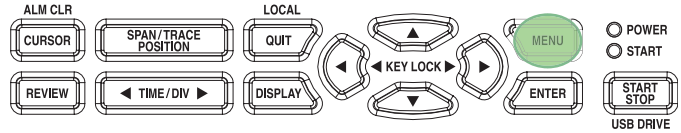
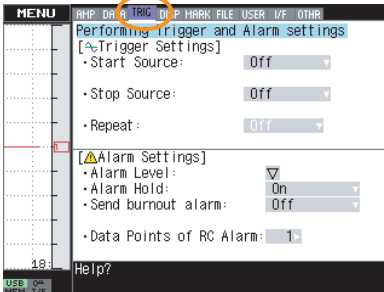

(2) Select Weekly for Start source setting.

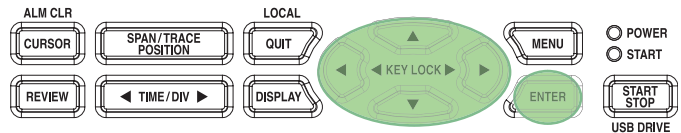
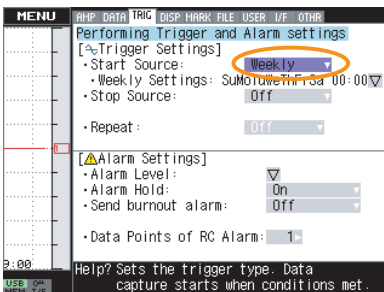

(3) Open the Weekly Settings and set On for Mondays only.

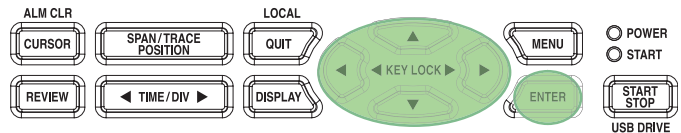
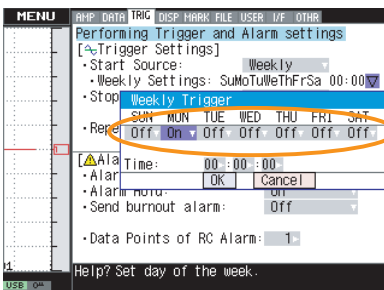

(4) Move the cursor to the time indicator and specify the time when the capture operation should begin.

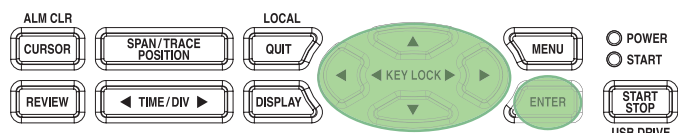
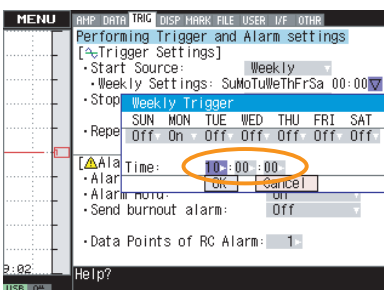

(5) Select Time for Stop source setting.

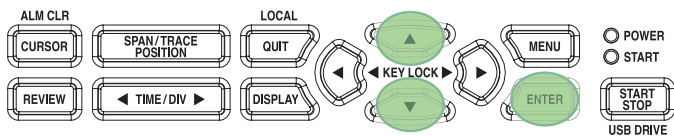
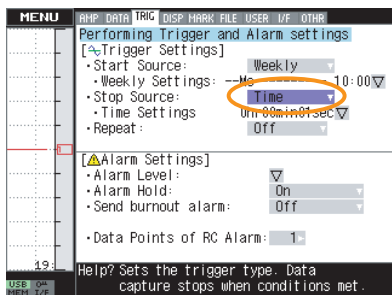

(6) Set 1 hour 00 minutes 00 seconds for Time.

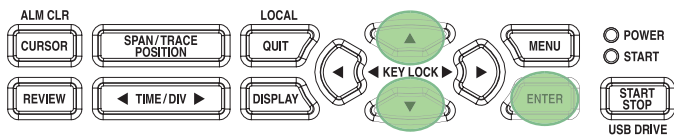
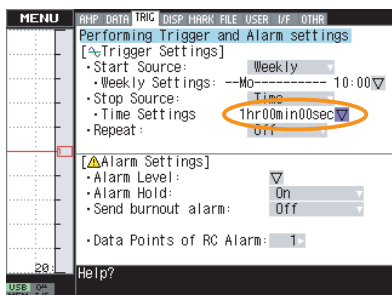

(7) Set Repeated capturing to ON.

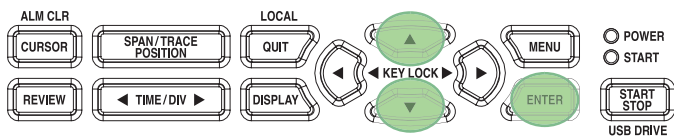
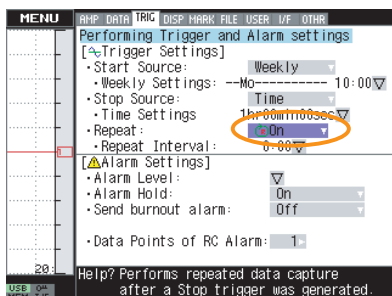

(Ex.7) Generating an alarm when measured temperature exceeds 100°C

This setting will generate an alarm when the measured temperature exceeds 100 °C and sets the Alarm 1 relay to ON.

(1) Press the MENU key to open the TRIG menu.

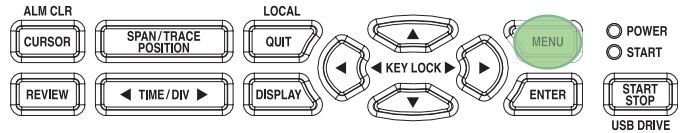
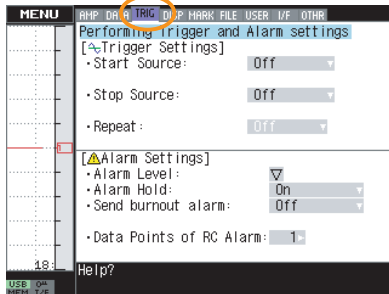

(2) Use the ∇ key to move to Alarm level settings.

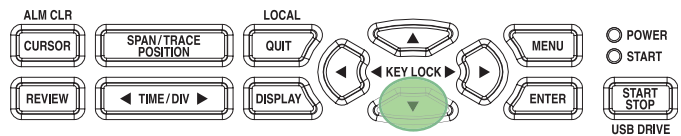
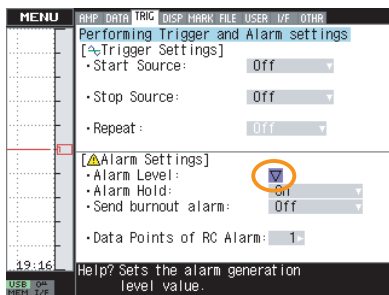

(3) Press the ENTER key to open the Alarm Level Settings menu.

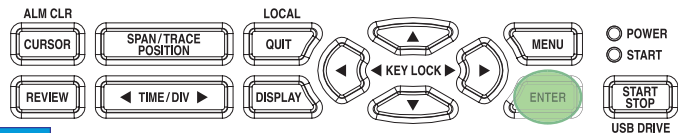
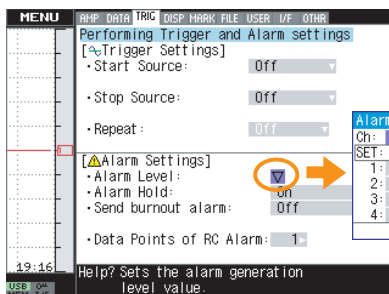

(4) Set the channel number to perform alarm comparison.

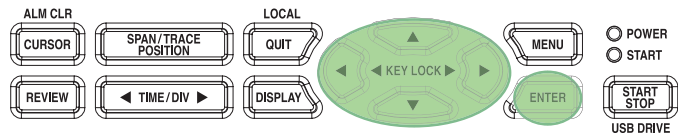
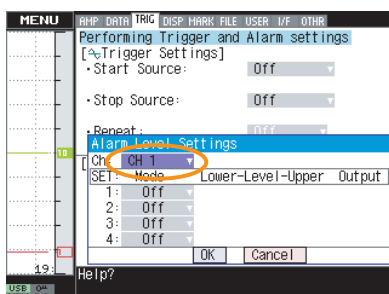

(5) Set the Mode to H.

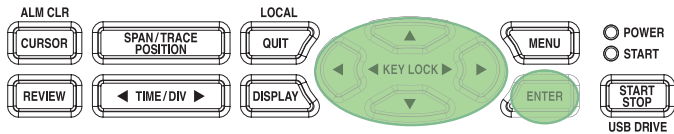
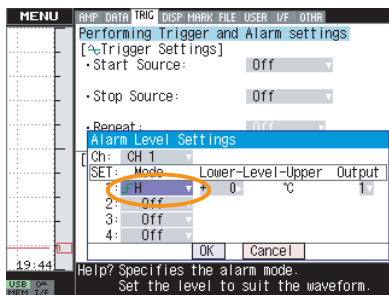

(6) Set the Level to 100°C.

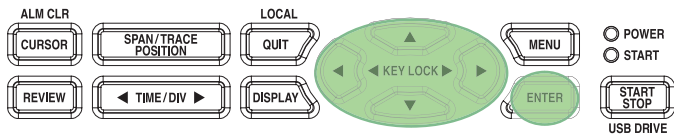
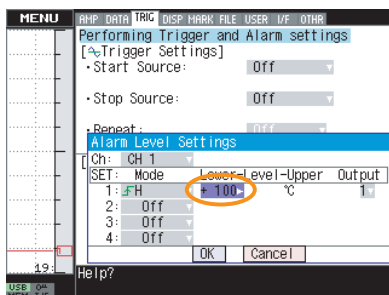

(7) Set the alarm Output number.

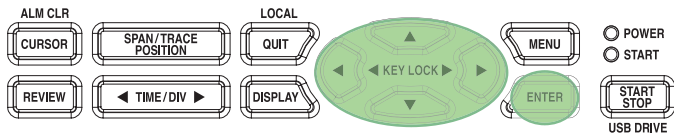
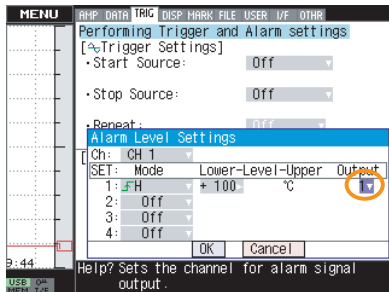

(8) Move the cursor to OK and press the ENTER key.

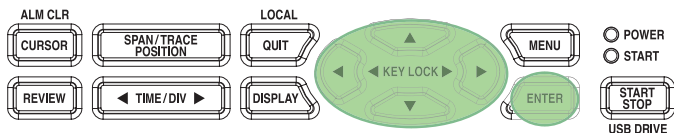
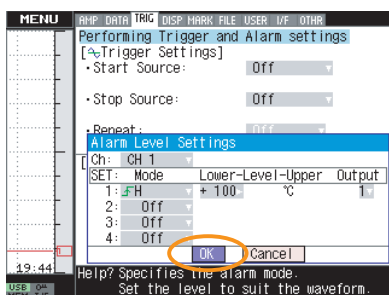

(Ex.8) Starting data capture automatically upon device power ON

The following procedure shows how to automatically start data capture when the device is powered on.

(1) Press the MENU key to open the TRIG menu.

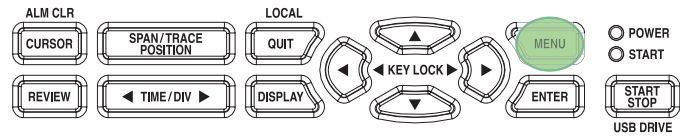
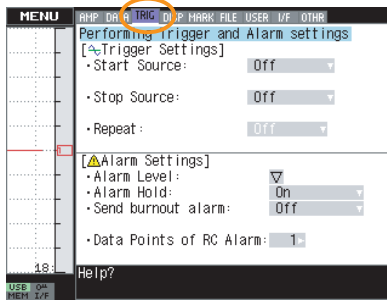

(2) Select OFF for Start source setting.

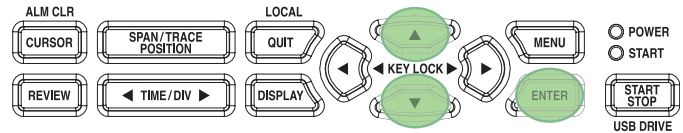
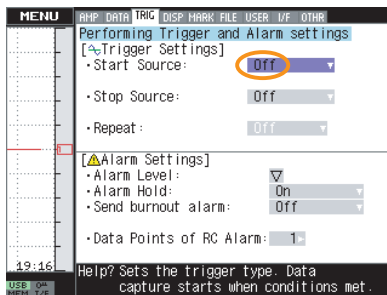

(3) Press the MENU key to open the OTHR menu.

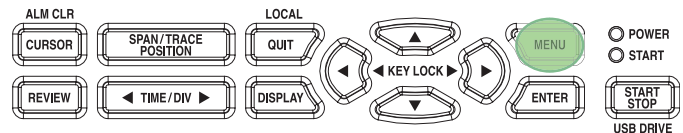
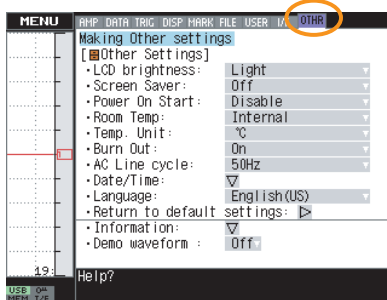

(4) Set Power On Start to Enable.

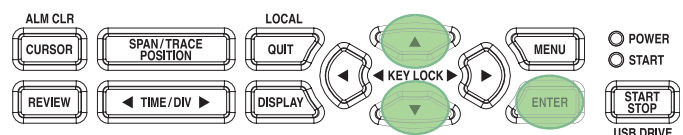
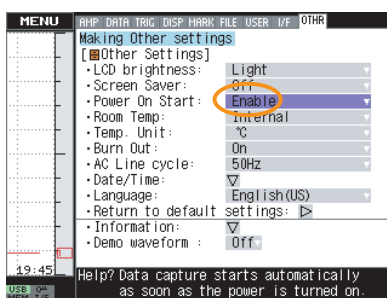

The device will automatically start data capture when powered on.

(Ex.9) Replaying captured data

The following procedure shows how to replay captured data.

(1) Press the REVIEW key to open the Data Replay Source menu.

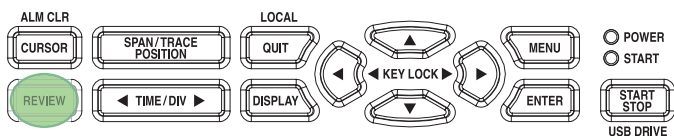
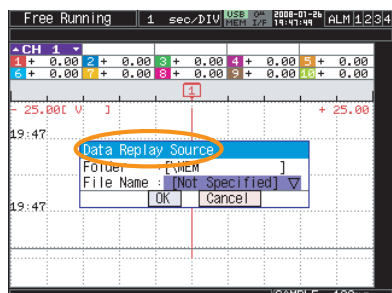

(2) Press the ENTER key to open the file selection menu.

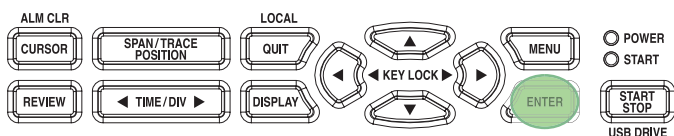
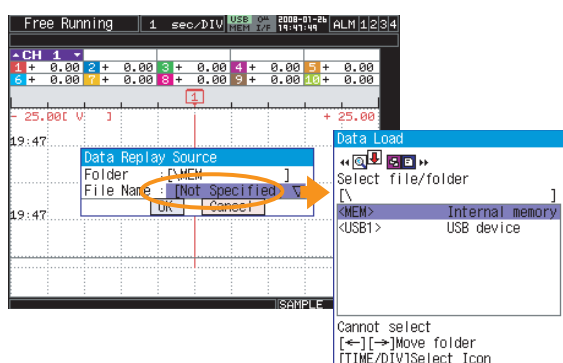

(3) Use the > key to display contents of the specified folder.

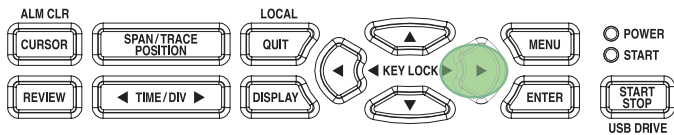
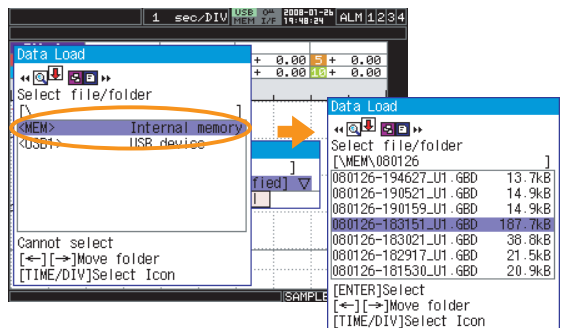

(4) Select the file to replay and press the ENTER key.

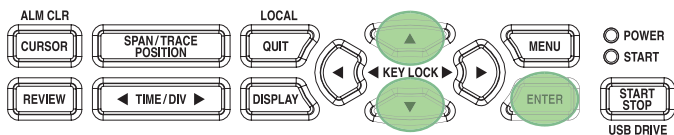
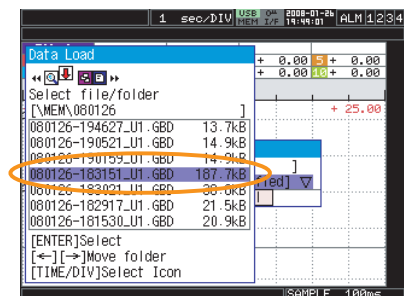

(5) Move the cursor to OK and press the ENTER key.

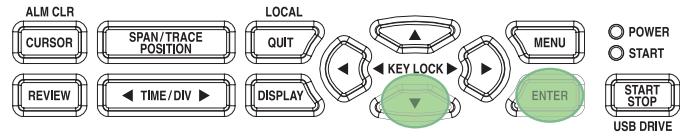
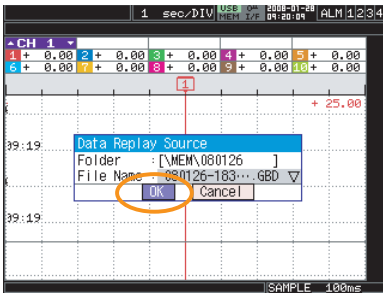

(6) Data will be displayed as shown below.

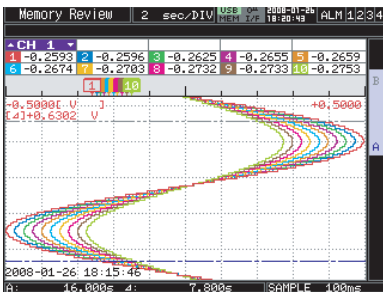

You can use the Δ ∇ keys to move the cursor and check the measured values. Use the CURSOR key to switch between cursors A/B. Press the MENU key to display the menu during replay. For details on the replay menu, see page 3-42.

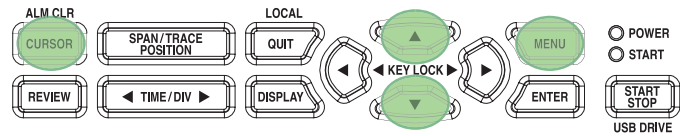

* Use the \triangleleft \triangleright keys to move cursors when scrolling direction is set to horizontal.

(Ex.10) Changing the display language

The following procedure shows how to change the language used in displays such as menus.

(1) Press the MENU key to open the OTHR menu.

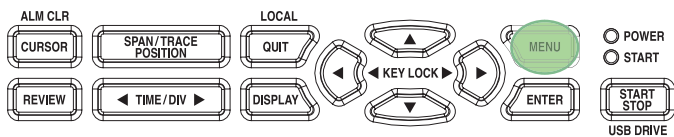
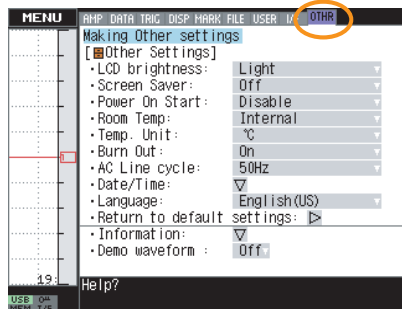

(2) Move the cursor to Language and press the ENTER key.

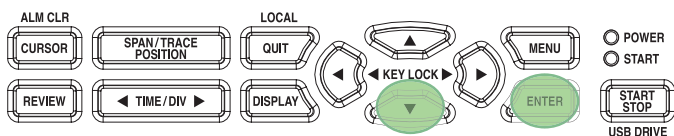
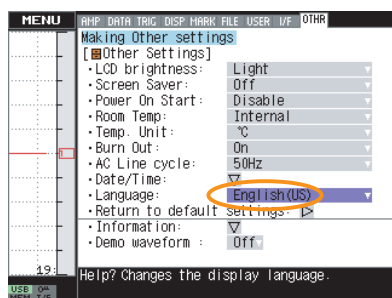

(3) Select a language from the list.

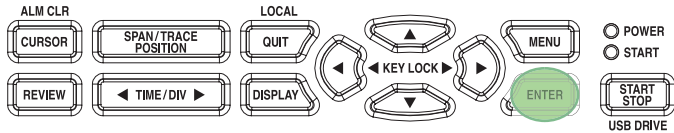
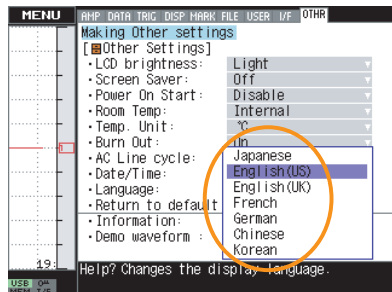

CHAPTER 4

Specifications

This chapter describes the basic specifications for the MT100.

- 4.1 Standard Specifications**
- 4.2 Function Specifications**
- 4.3 Accessory/Option Specifications**
- 4.4 External Dimensions**
- 4.5 Panel Cut-out Dimensions
(Mounting Single Device)**
- 4.6 Panel Cut-out Dimensions
(Mounting Multiple Devices)**

4.1 Standard Specifications

Standard Specifications

Item	Description									
Number of analog input	1 unit (10 channels)									
External input/output	Trigger input, Logic input 4 channels or Pulse input 4 channels, Alarm output									
PC Interface	Ethernet (10BASE-T/100BASE-TX), USB (FullSpeed supported) provided as standard features									
Internal memory devices	Internal memory: Approx. 14 MB USB memory slot (FullSpeed supported) provided as a standard feature									
Data backup functions	Setup conditions: EEPROM; Clock: Lithium secondary battery									
Clock accuracy (23°C environment)	±0.002 % (approx. 50 seconds per month)									
Operating environment	0 to 50°C, 5 to 85 % RH									
Withstand voltage	Between each input channel and GND : 1 minute at 350 Vp-p Between each input terminal : 1 minute at 350 Vp-p Between AC input and GND : 1 minute at 2000 VAC Between alarm terminal and GND : 1 minute at 1000 VAC									
Insulation resistance	Between AC input and GND : 20M or higher (500VDC) Between alarm terminal and GND : 50M or higher (500VDC) Between each input channel and GND : 50M or higher (500VDC)									
Power supply	AC input : 100 to 240 VAC/50 to 60 Hz Terminal type : M4 screw type terminals									
Power consumption	AC power consumption <table border="1"> <thead> <tr> <th>No.</th> <th>Condition</th> <th></th> </tr> </thead> <tbody> <tr> <td>1</td> <td>When the LCD is ON</td> <td>38VA</td> </tr> <tr> <td>2</td> <td>When the screensaver is operating</td> <td>30VA</td> </tr> </tbody> </table> <p>* Normal status is when LCD brightness is set to MAX.</p>	No.	Condition		1	When the LCD is ON	38VA	2	When the screensaver is operating	30VA
No.	Condition									
1	When the LCD is ON	38VA								
2	When the screensaver is operating	30VA								
External dimensions	144 x 144 x 200 mm									
Weight	2.1 kg									
Vibration-tested conditions	Protective class : IP65 compatible (surface panel only) Vibration : Equivalent to automobile parts Type 1 Category A classification									

Internal Memory Devices

Item	Description
Memory capacity	Internal memory : Approx. 14 MB Flash Memory USB memory : Max 2 GB (depends on the type of USB memory used)
Memory contents	Setup conditions, measured data, screen copy

PC Interface

Item	Description
Interface types	Ethernet (10BASE-T/100BASE-TX) USB (FullSpeed)
Software functions	Data transfer to the PC (realtime, memory) PC control of the MT100
Ethernet functions (10BASE-T/100BASE-TX)	Web server function : Displays MT100's screen image on Web browser, operation of MT100 FTP server function : Transfers and deletes files from internal memory and USB memory FTP client function : Supports backup of data in internal memory and USB memory NTP client function : Adjusts internal clock
USB functions	USB drive mode : Transfers and deletes files from internal memory
Realtime data transfer speed	100 msec/10 ch maximum

Monitor

Item	Description
Display	5.7-inch TFT color LCD (QVGA: 320 x 240 dots)
Displayed languages	Japanese, English, Others
Backlight life	40,000 hrs (when brightness is down to 50 %), depends on operation environment
Backlight	Screen saver function provided (10, 30 sec; 1, 2, 5, 10, 30, 60 min.) Off during operation, resumed by key operation and alarm

4.2 Function Specifications

Function Specifications

Item	Description
Display screen	Waveform screen + Digital screen (vertical, horizontal), Digital screen + Calculation Display screen, Bar Graph screen (vertical) Note: Can be key-toggled
Sampling interval	100 ms/10 ch maximum 100, 125, 200, 250, 500 ms; 1, 2, 5, 10, 20, 30 sec; 1, 2, 5, 10, 20, 30 min; 1 h
TIME/DIV	1, 2, 5, 10, 20, 30 sec/DIV; 1, 2, 5, 10, 20, 30 min/DIV; 1, 2, 5, 10, 12, 24, 72 h/DIV
EU (scaling function)	4 points can be set for each channel
Bar graph display	Display direction : Vertical, 10 ch + pulse 4 ch Reference position : Bottom or center Scale divided into : 10 (fixed)
Review function	Data replay during data capture
Data save functions	Capture to internal memory Capture to USB memory Setup data can be saved (to internal or USB memory) Copy of data screen can be saved (to internal or USB memory) Back up function (internal memory -> USB memory, internal memory -> PC*1, USB memory -> PC*1) File name increment feature Note: USB memory can be removed during data capture.
Statistical calculation	Types of statistical calculation : Average value, peak value, maximum value, minimum value, RMS Number of operations : Maximum of 2 can be set simultaneously Method : Realtime and between cursors specified (during data replay) Note: Realtime calculation results are displayed in Digital screen + Calculation Display screen.
Calculation between channels	Calculation types : Addition, subtraction, multiplication, division Input : Analog ch 1 to 10
Wet and dry bulb conversion	Function : Converts dry bulb or wet bulb temperature to humidity Dry bulb : 1 ch fixed (input temperature, outputs temperature) Wet bulb : 2 ch fixed (input wet bulb temperature, calculates humidity with 1 ch temperature. Outputs humidity.) Measurement range : 0 to 100 % RH Note: Some dry bulb or wet bulb temperatures may not be calculated.
Search functions	Function : Search the captured data for the required number of points Search type : Channel, Pulse, Logic, Level, Alarm search
Annotation input function	Function : A comment can be input for each channel Inputtable characters : Alphanumerics Number of characters : 11 (displayed up to 8 characters)
Message/marker function	Function : Records message/marker at the specified timing Number of registered messages : 8 Markers : Start/stop, trigger, alarm, power failure Messages : Input arbitrary messages before capture

*1: Uses FTP (LAN connection required).

Trigger Functions

Item	Description
Repeat Trigger	Off, On
Trigger types	Start : Data capture starts when a trigger is generated Stop : Data capture stops when a trigger is generated
Trigger settings	Start : Off, Level, Alarm, External, Date, Weekly Stop : Off, Level, Alarm, External, Date, Weekly, Time
Trigger judgment modes	Analog : H, L, Window In, Window Out Logic : H, L Pulse : H, L, Window In, Window Out

External Input/Output Functions

Item	Description
Input/output types	<ul style="list-style-type: none"> • Trigger input (1 ch) • Logic input (4 ch) or Pulse input (4 ch) • Alarm output (4 ch) <p>*Switch between Logic and Pulse</p>
Input specifications	Terminal type : M4 screw type terminals Maximum input voltage : 0 to 24 V (single-ended ground input) Input threshold voltage : Approx. 2.5 V Hysteresis : Approx. 0.5 V (+ 2.5 to + 3 V)
Alarm output specifications	Output format : Relay contact output (NO/NC) Terminal type : M4 screw type terminals Rated : 250 VAC/2A Output conditions : Level judgment, window judgment, logic pattern judgment, pulse judgment, rate of change judgement <p>*Set output conditions of four channel values.</p>
Pulse input	Revolutions mode (engines, etc.) Function : Counts the number of pulses per second; enables them to be converted to rpms Span : 50, 500, 5000, 50 k, 500 k, 5 M, 50 M, 500 M RPM/F.S. <hr/> Counts mode (electric meters, etc.) Function: Displays a count of the number of pulses for each sampling interval from the start of measurement Span : 50, 500, 5000, 50 k, 500 k, 5 M, 50 M, 500 M C/F.S. <hr/> Inst. Mode Function: Counts the number of pulses for each sampling interval Resets the count value after each sampling interval Span : 50, 500, 5000, 50 k, 500 k, 5 M, 50 M, 500 M C/F.S. <hr/> Maximum number of pulse input Counts, Inst. Modes : 50 k/sampling interval Revolution counts mode : 50 k/s

Control Software

Item	Description
Compatible operating system	Windows 2000, XP, Vista (32-bit version, 64-bit version)
Functions	Main unit control, realtime data capture, data conversion
Allowed connection	Up to 10
Number of channels per connection	10 ch maximum
Maximum number of channels	100 ch maximum
Settings	AMP settings, data settings, trigger/alarm settings, report settings, others
Captured data	Realtime data (CSV, Binary) Memory data (CSV, Binary) USB memory data (CSV, Binary)
Display	Analog waveforms, logic waveforms, pulse waveforms, digital values
Display modes	Y-T View, X-Y View, Digital View, Meter View, Report View
File conversion	Between cursors, All data
Monitor functions	Alarm monitor enables sending of email to the specified address
Dual-screen function	Displays the current data alongside past data
Statistic/History	Displays maximum, minimum, and average values during measurement
Report function	Enables creation of daily or monthly files

Input Unit Specifications

Item	Description																																																						
Number of input channels	10 channels																																																						
Input terminal type	M4 screw type terminals																																																						
Input method	Photo MOS relay scanning system All channels isolated, balanced input																																																						
Scan speed	0.1s/10 ch maximum																																																						
Measurement ranges	Voltage: 20, 50, 100, 200, 500 mV; 1, 2, 5, 10, 20, 50 V; 1-5 V F.S. Temperature • Thermocouples: K, J, E, T, R, S, B, N, W (WRe5-26) • Resistance temperature detector: Pt100, JPt100, Pt1000 (IEC751) Humidity: 0 to 100% (voltage 0 V to 1 V scaling conversion) *with B-530 (option)																																																						
Measurement accuracy*1 (23°C ±5°C) • When 30 minutes or more have elapsed after power was switched on • Sampling 1 s/10 ch • Filter ON (10) • GND connected	Voltage: 0.1% of F.S. Temperature • Thermocouple <table border="1"> <thead> <tr> <th>Thermo couple</th> <th>Measurement Temperature Range (°C)</th> <th>Measurement Accuracy</th> </tr> </thead> <tbody> <tr> <td rowspan="4">R/S</td> <td>0 ≤ Ts ≤ 100</td> <td>±5.2°C</td> </tr> <tr> <td>100 < Ts ≤ 300</td> <td>±3.0°C</td> </tr> <tr> <td>R: 300 < Ts ≤ 1600°C</td> <td>±(0.05% of rdg +2.0°C)</td> </tr> <tr> <td>S: 300 < Ts ≤ 1760°C</td> <td>±(0.05% of rdg +2.0°C)</td> </tr> <tr> <td>B</td> <td>400 ≤ Ts ≤ 600 600 < Ts ≤ 1820°C</td> <td>±3.5°C ±(0.05% of rdg +2.0°C)</td> </tr> <tr> <td>K</td> <td>-200 ≤ Ts ≤ -100 -100 < Ts ≤ 1370°C</td> <td>±(0.05% of rdg +2.0°C) ±(0.05% of rdg +1.0°C)</td> </tr> <tr> <td>E</td> <td>-200 ≤ Ts ≤ -100 -100 < Ts ≤ 800°C</td> <td>±(0.05% of rdg +2.0°C) ±(0.05% of rdg +1.0°C)</td> </tr> <tr> <td>T</td> <td>-200 ≤ Ts ≤ -100 -100 < Ts ≤ 400°C</td> <td>±(0.1% of rdg +1.5°C) ±(0.1% of rdg +0.5°C)</td> </tr> <tr> <td rowspan="2">J</td> <td>-200 ≤ Ts ≤ -100</td> <td>±2.7°C</td> </tr> <tr> <td>-100 < Ts ≤ 100 100 < Ts ≤ 1100°C</td> <td>±1.7°C ±(0.05% of rdg +1.0°C)</td> </tr> <tr> <td>N</td> <td>0 ≤ Ts ≤ 1300°C</td> <td>±(0.1% of rdg +1.0°C)</td> </tr> <tr> <td>W</td> <td>0 ≤ Ts ≤ 2000°C</td> <td>±(0.1% of rdg +1.5°C)</td> </tr> <tr> <td colspan="2">Reference contact compensation accuracy</td> <td>±0.5°C</td> </tr> </tbody> </table> <p>*1: Thermocouple diameters T: 0.32 φ, others: 0.65 φ</p> <p>• Resistance temperature detector</p> <table border="1"> <thead> <tr> <th>Type</th> <th>Measurement Temperature Range (°C)</th> <th>Applied current</th> <th>Measurement Accuracy</th> </tr> </thead> <tbody> <tr> <td>Pt100</td> <td>-200 to 850°C (FS=1050°C)</td> <td>1mA</td> <td>±(0.05% of rdg +0.5°C)</td> </tr> <tr> <td>Jpt100</td> <td>-200 to 500°C (FS=700°C)</td> <td>1mA</td> <td>±(0.05% of rdg +0.5°C)</td> </tr> <tr> <td>Pt1000</td> <td>-200 to 500°C (FS=700°C)</td> <td>0.2mA</td> <td>±(0.05% of rdg +0.5°C)</td> </tr> </tbody> </table>	Thermo couple	Measurement Temperature Range (°C)	Measurement Accuracy	R/S	0 ≤ Ts ≤ 100	±5.2°C	100 < Ts ≤ 300	±3.0°C	R: 300 < Ts ≤ 1600°C	±(0.05% of rdg +2.0°C)	S: 300 < Ts ≤ 1760°C	±(0.05% of rdg +2.0°C)	B	400 ≤ Ts ≤ 600 600 < Ts ≤ 1820°C	±3.5°C ±(0.05% of rdg +2.0°C)	K	-200 ≤ Ts ≤ -100 -100 < Ts ≤ 1370°C	±(0.05% of rdg +2.0°C) ±(0.05% of rdg +1.0°C)	E	-200 ≤ Ts ≤ -100 -100 < Ts ≤ 800°C	±(0.05% of rdg +2.0°C) ±(0.05% of rdg +1.0°C)	T	-200 ≤ Ts ≤ -100 -100 < Ts ≤ 400°C	±(0.1% of rdg +1.5°C) ±(0.1% of rdg +0.5°C)	J	-200 ≤ Ts ≤ -100	±2.7°C	-100 < Ts ≤ 100 100 < Ts ≤ 1100°C	±1.7°C ±(0.05% of rdg +1.0°C)	N	0 ≤ Ts ≤ 1300°C	±(0.1% of rdg +1.0°C)	W	0 ≤ Ts ≤ 2000°C	±(0.1% of rdg +1.5°C)	Reference contact compensation accuracy		±0.5°C	Type	Measurement Temperature Range (°C)	Applied current	Measurement Accuracy	Pt100	-200 to 850°C (FS=1050°C)	1mA	±(0.05% of rdg +0.5°C)	Jpt100	-200 to 500°C (FS=700°C)	1mA	±(0.05% of rdg +0.5°C)	Pt1000	-200 to 500°C (FS=700°C)	0.2mA	±(0.05% of rdg +0.5°C)
Thermo couple	Measurement Temperature Range (°C)	Measurement Accuracy																																																					
R/S	0 ≤ Ts ≤ 100	±5.2°C																																																					
	100 < Ts ≤ 300	±3.0°C																																																					
	R: 300 < Ts ≤ 1600°C	±(0.05% of rdg +2.0°C)																																																					
	S: 300 < Ts ≤ 1760°C	±(0.05% of rdg +2.0°C)																																																					
B	400 ≤ Ts ≤ 600 600 < Ts ≤ 1820°C	±3.5°C ±(0.05% of rdg +2.0°C)																																																					
K	-200 ≤ Ts ≤ -100 -100 < Ts ≤ 1370°C	±(0.05% of rdg +2.0°C) ±(0.05% of rdg +1.0°C)																																																					
E	-200 ≤ Ts ≤ -100 -100 < Ts ≤ 800°C	±(0.05% of rdg +2.0°C) ±(0.05% of rdg +1.0°C)																																																					
T	-200 ≤ Ts ≤ -100 -100 < Ts ≤ 400°C	±(0.1% of rdg +1.5°C) ±(0.1% of rdg +0.5°C)																																																					
J	-200 ≤ Ts ≤ -100	±2.7°C																																																					
	-100 < Ts ≤ 100 100 < Ts ≤ 1100°C	±1.7°C ±(0.05% of rdg +1.0°C)																																																					
N	0 ≤ Ts ≤ 1300°C	±(0.1% of rdg +1.0°C)																																																					
W	0 ≤ Ts ≤ 2000°C	±(0.1% of rdg +1.5°C)																																																					
Reference contact compensation accuracy		±0.5°C																																																					
Type	Measurement Temperature Range (°C)	Applied current	Measurement Accuracy																																																				
Pt100	-200 to 850°C (FS=1050°C)	1mA	±(0.05% of rdg +0.5°C)																																																				
Jpt100	-200 to 500°C (FS=700°C)	1mA	±(0.05% of rdg +0.5°C)																																																				
Pt1000	-200 to 500°C (FS=700°C)	0.2mA	±(0.05% of rdg +0.5°C)																																																				
Reference contact compensation accuracy	Internal/External switching																																																						
A/D converter	16 bits (out of which 14 bits are internally acknowledged)																																																						
Temperature coefficient	Gain: 0.01% of F.S./ °C																																																						
Input resistance	1 MΩ ±5%																																																						
Allowable signal source resistance	Within 300 Ω																																																						
Maximum permissible input voltage	Between +/- terminals : 60 Vp-p Between input terminal/input terminal : 60 Vp-p Between input terminal/GND : 60 Vp-p																																																						
Withstand voltage	Between input terminal/input terminal : 1 minute at 350 Vp-p Between input terminal/GND : 1 minute at 350 Vp-p																																																						
Insulation resistance	Between input terminal/GND : At least 50MΩ (at 500 VDC)																																																						
Common mode rejection ratio	At least 90 dB (50/60 Hz; signal source 300 Ω or less)																																																						
Noise	At least 48 dB (with +/- terminals shorted)																																																						
Filter	Off, 2, 5, 10, 20, 40 Filter operation is on a moving average basis. The average value of the set sampling count is used.																																																						

4.3 Accessory/Option Specifications

Accessories

Item Name	Description	Quantity
Quick Start Guide	MT100-UM-8xx (Japanese and English supported, with Japanese warranty)	1
CD-ROM	MT100-CDM0xM (User Manual, Application software)	1
Panel mount bracket	1 set includes two brackets	2

Desktop Case B-541 (Option)

Item	Description																				
Contents	Desktop case, power cable (corresponding to area), instruction manual, screws (4) 3-pin to 2-pin conversion plug included (Japan only)																				
Power supply cord rating and length	<table border="0"> <tr> <td>Japan</td> <td>: 125 V/7 A</td> <td>Approx. 1.8 m</td> <td>J suffix</td> </tr> <tr> <td>UL</td> <td>: 125 V/10 A</td> <td>Approx. 1.8 m</td> <td>U suffix</td> </tr> <tr> <td>CEE</td> <td>: 250 V/10 A</td> <td>Approx. 1.8 m</td> <td>E suffix</td> </tr> <tr> <td>BS</td> <td>: 250 V/10 A</td> <td>Approx. 1.8 m</td> <td>B suffix</td> </tr> <tr> <td>CCC</td> <td>: 250 V/10 A</td> <td>Approx. 1.8 m</td> <td>C suffix</td> </tr> </table> <p><i>*Bare tips for BS cord</i></p>	Japan	: 125 V/7 A	Approx. 1.8 m	J suffix	UL	: 125 V/10 A	Approx. 1.8 m	U suffix	CEE	: 250 V/10 A	Approx. 1.8 m	E suffix	BS	: 250 V/10 A	Approx. 1.8 m	B suffix	CCC	: 250 V/10 A	Approx. 1.8 m	C suffix
Japan	: 125 V/7 A	Approx. 1.8 m	J suffix																		
UL	: 125 V/10 A	Approx. 1.8 m	U suffix																		
CEE	: 250 V/10 A	Approx. 1.8 m	E suffix																		
BS	: 250 V/10 A	Approx. 1.8 m	B suffix																		
CCC	: 250 V/10 A	Approx. 1.8 m	C suffix																		

Humidity Sensor B-530 (Option)

Item	Description
Allowable temperature range	- 25 to +80°C
Allowable humidity range	0 to 100 % RH
Relative humidity measurement accuracy	±3 % RH (5 to 98 % RH at 25°C)
Response time	15 sec (90 % response when membrane filter installed)
Sensor output	0 to 1 VDC
Sensor power source	5 to 16 VDC
Power consumption	Approx. 4 mA
External dimensions	φ14 mm x 80 mm (excluding cable)
Cable length	3 m

Options

Item Name	Model	Description
Desktop case	B-541	Desktop case, power cable (for each area), instruction manual, screws (4), 3-pin to 2-pin conversion plug included (Japan only)
Humidity sensor	B-530	3 m, with dedicated power connector
T-type thermocouple	JBS-7115-5M-T	5 m, set of 5
K-type thermocouple	JBS-7115-5M-K	5 m, set of 5
K-type thermocouple (needle type probes)	RIC-410	1.1 m
K-type thermocouple (stationary surface probes)	RIC-420	1.1 m
K-type thermocouple (stationary surface L probes)	RIC-430	1.1 m

4.4 External Dimensions

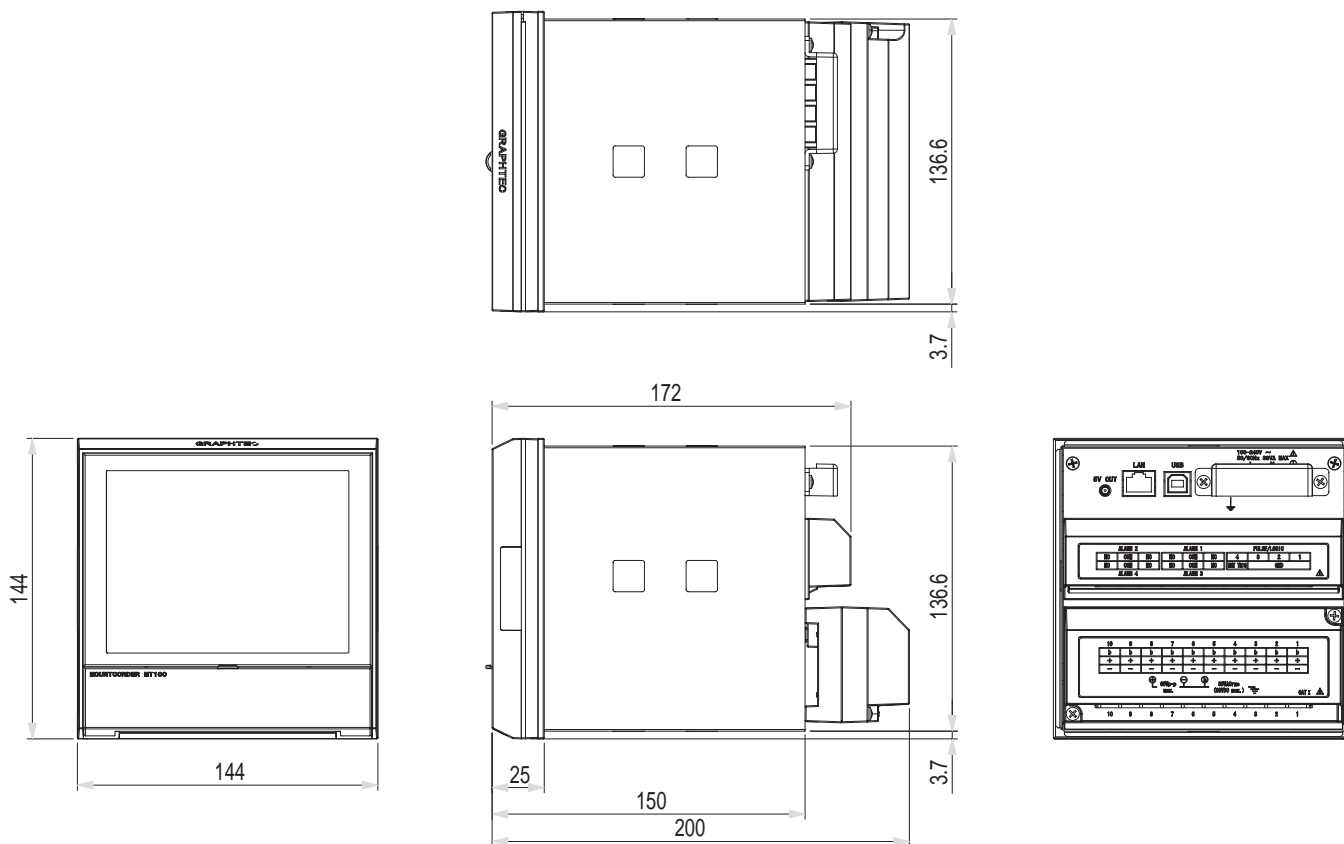

Dimensional precision: ± 5 mm
Unit: mm

4.5 Panel Cut-out Dimensions (Mounting Single Device)

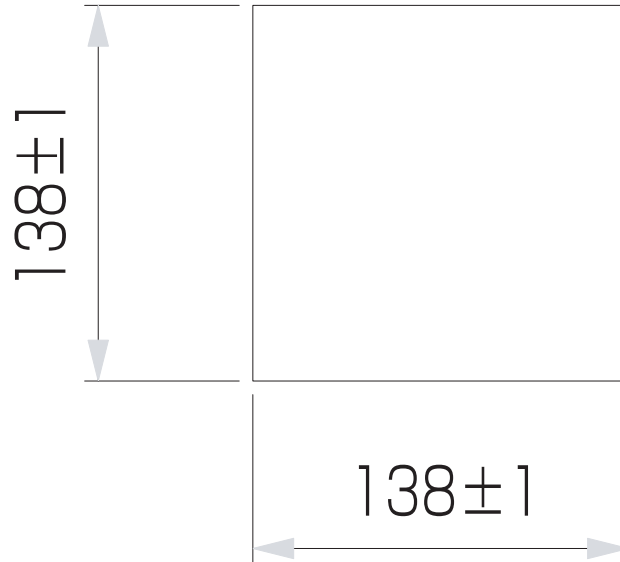

4.6 Panel Cut-out Dimensions (Mounting Multiple Devices)

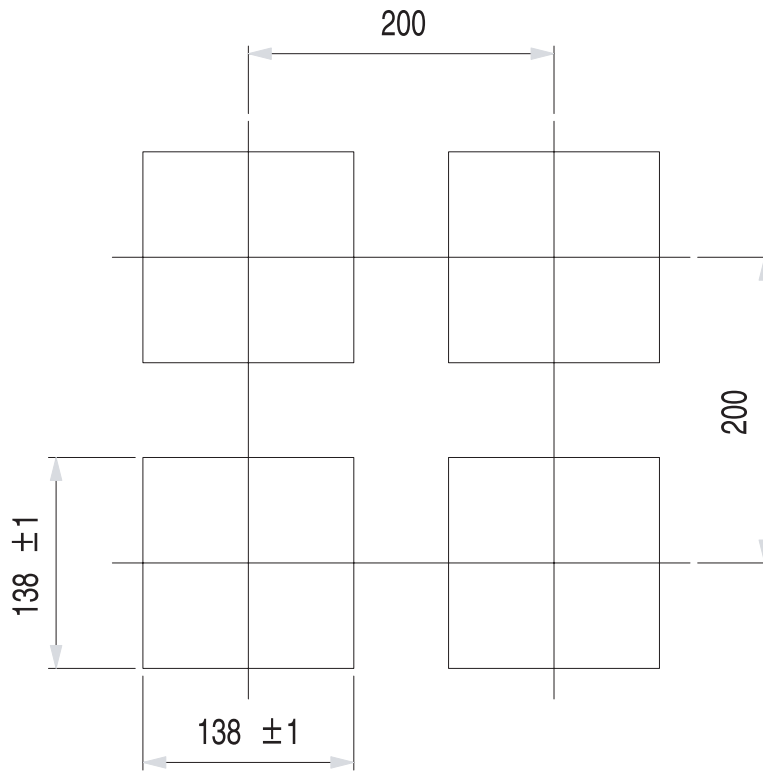

The specifications, etc., in this manual are subject to change without notice.

MT100-UM-151

Mar 1, 2008 1st edition-01

GRAPHTEC CORPORATION

GRAPHTEC