

DI-4718B USB or Ethernet Data Acquisition (DAQ) System



- ✓ Eight inputs designed specifically for DI-8B style plug-in amplifiers
- ✓ PC-connected or Stand-alone operation
- ✓ Multi-unit synchronization with ChannelStretch™ for higher channel count applications (requires Unlock Code)
- ✓ Adaptable anti-alias filter per channel
 - ✓ Corner frequency set as a function of sampling rate
- ✓ Up to 16-bit analog-to-digital resolution
- ✓ Up to 160 kHz sample throughput rate
- ✓ Two digital ports
 - ✓ Remote Events control for WinDaq Acquisition software applications
 - ✓ Remote Storage control for WinDaq and stand-alone operation
- ✓ Stand-alone operation records to USB flash drive
 - ✓ Circular/trigger mode
- ✓ Software support includes:
 - ✓ Ready-to-run WinDaq software
 - ✓ Published protocol for software development in all operating systems

Overview

Model DI-4718B is an eight-channel instrument designed for general purpose and stand-alone data logging applications that require signal conditioning. Install up to eight DI-8B isolated signal conditioning modules on the printed circuit board using the removable front panel. DI-8B modules are the world's smallest, fully functional and isolated analog signal conditioners. Each DI-8B module protects, filters, amplifies, and isolates an input signal, providing an advanced signal conditioning solution for nearly any industrial measurement.

Add up to 128 analog channels with ChannelStretch™ channel expansion, which is supported in all USB and Ethernet versions. Synchronize any USB DI-4718Bs, DI-4108s, DI-4208s, and/or DI-1120s to one PC or synchronize multiple DI-4718B Ethernet units. Acquire from as many as 128 analog and 112 digital channels at combined total throughput rates over 480 kHz.

Analog Subsystem

Model DI-4718B features 12- to 16-bit analog-to-digital resolution as a function of sample rate. Lower sampling rates deliver higher resolution readings. The maximum analog sampling throughput rate of the DI-4718B analog subsystem is 160 kHz, providing 12 bits of resolution. Resolution varies with respect to sample rate. See inside for details.

Stand-alone Operation

A USB drive is used to record data in stand-alone mode. The DI-4718B can record continuously using a circular buffer with pre-defined trigger conditions or a record-until-full approach supporting remote start/stop. A push button allows manual start/stop control over the recording process. With a flash memory card incorporating SLC technology, throughput rates up to 160 kHz can be achieved. That rate drops to 50 kHz when using pSLC card, and 20 kHz using a flash memory card incorporating MLC. The included WinDaq data acquisition software makes configuring the DI-4718B for stand-alone operation quick and intuitive. Use WinDaq to set up channels and create a reference file. That reference file can then be copied to the USB drive and used for quick setup.

Software Overview

Model DI-4718B is provided with comprehensive software support. For point-and-click, ready-to-run applications the DI-4718B is supplied with our popular WinDaq software. WinDaq allows a real time display of any combination of analog channels, and the ability to stream acquired data to disk in recorder-like fashion, even at the fastest rate supported by the hardware. This is true streaming performance, continuous, without gaps, and simultaneously to both the real time display and disk. Record only a few readings, or as many as 2 GB (total file size of 4GB). The DI-4718B reserves two digital inputs for WinDaq software that are dedicated for remote stop/start and remote event operations. WinDaq also includes software to review recorded data files, including waveform analysis and data file export to Microsoft Excel and other applications. Custom programming the DI-4718B is supported through its protocol documentation. Finally, the DI-4718B supports ChannelStretch™ technology, allowing multiple instruments (DI-4108, -4208, -1120) to be synchronized to expand channel count without clumsy external cabling (details inside).

Interface Options

The DI-4718B provides three interface options: USB, Ethernet, and Power over Ethernet. All 3 have stand-alone capability (optional Unlock Code required to record more than one channel to flash memory) to record to flash memory.

USB allows for quick plug-and-play access to your DI-4718B. Using ChannelStretch™ technology, and cascading multiple USB hubs, add up to 15 additional instruments (a total of 128 analog channels and 105 digital ports) with a maximum throughput sample rate \geq 480 kHz.

Ethernet allows you to access your DI-4718B over much greater distances (up to 100 meters between stations). Connect directly to a PC, to a LAN port, or wirelessly using an access point. Using wireless hubs and ChannelStretch™ technology, you can add up to 15 additional units at throughput sample rates \geq 50 kHz.

Power over Ethernet (PoE) gives you the same functionality as the standard Ethernet connection, but also provides power to the DI-4718B using a PoE-enabled switch. This eliminates the costly expense of running power to a remote location where data acquisition may be essential.

DI-4718B Front Panel

Removable Screw Terminal Blocks

Connect signal leads to this screw terminal block. Channel +, Channel -, Excitation +, and Excitation - for each channel.

Remote Control Jack

3.5mm stereo phone plug provides access to Remote Events and Remote Start/Stop Recording control feature.

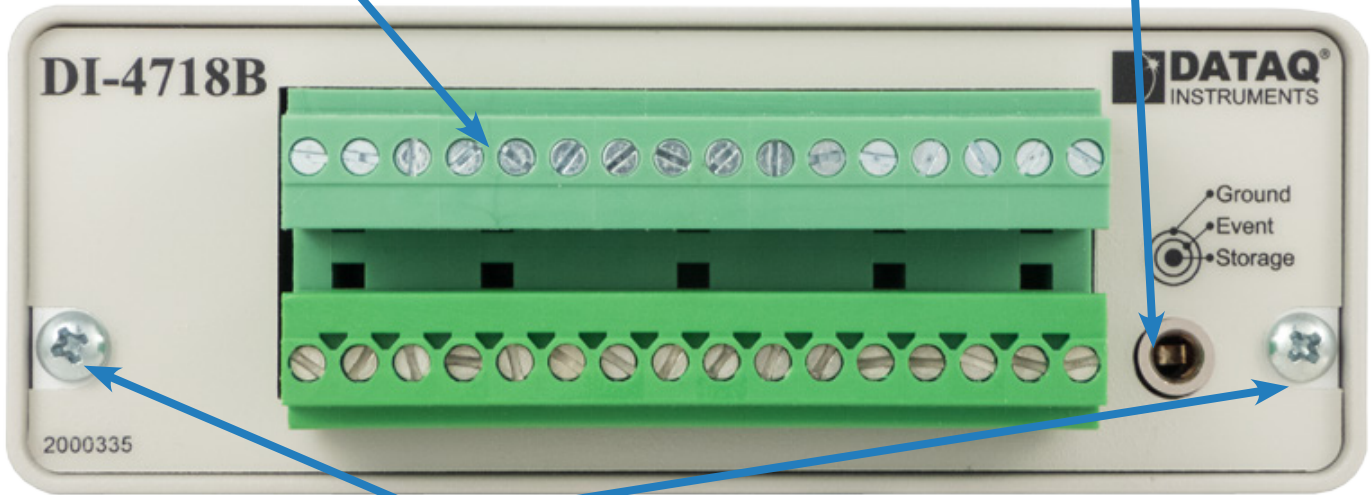

Removable Front Panel

Remove these two screws to install your DI-8B modules.

DI-4718B Rear Panel

Power Jack

May be powered by the provided AC adaptor, or from any 9-36 VDC source. Consumes 2 watts (excluding 8B modules).

Mini "B" USB Connector

Standard USB communications interface connector.

Status LED

Multi-color LED indicates instrument status.

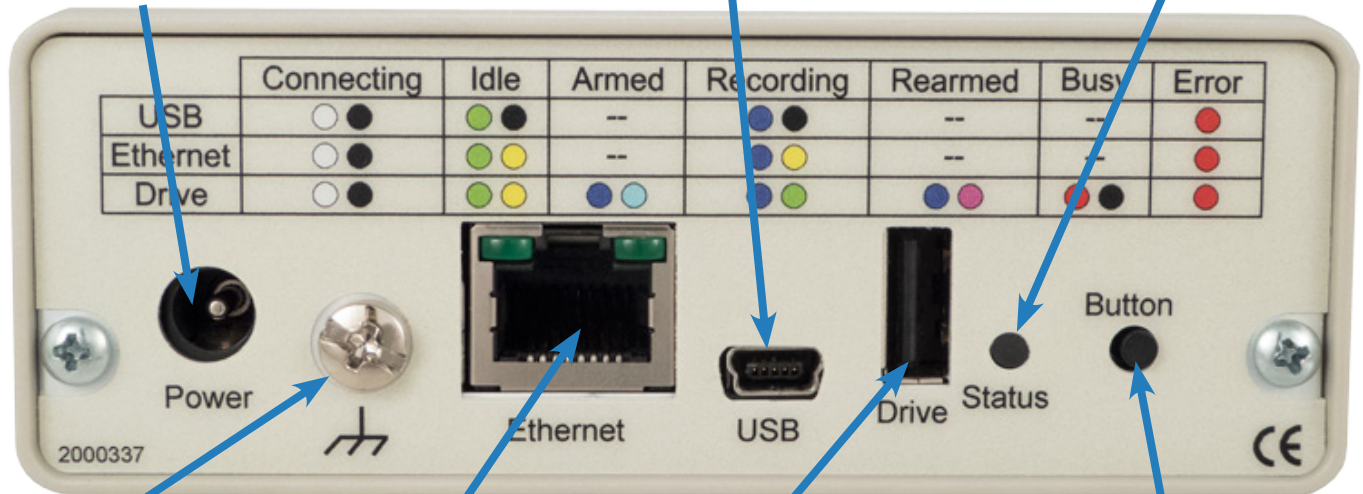

Ground Lug

Earth Ground.

Ethernet Connector

Standard RJ45 connector. Power over Ethernet option available. Ethernet Connector not available on USB model.

USB Drive

Accepts any USB flash drive or USB reader for stand-alone data logging.

"Control" Push-button

Allows manual start/stop local control over the recording process and instrument configuration.

DI-4718B Major Features and Benefits

Eight Signal-conditioned Input Channels

Measure temperature, pressure, flow, current, voltage, and more using isolated DI-8B amplifiers.

Stand-alone Data Logger Operation

Store data to flash drives at throughput rates up to 160kHz.

Optional Ethernet Interface

Connect via LAN or over the Internet for configuration and data acquisition.

Pre/Post Trigger Storage to USB Memory

Set trigger levels to record up to 2G (combined) of pre- and post-trigger data (total file size of 4G).

Fast, 160 kHz Sample Throughput Rate

Observe fast phenomena that other products in the DI-4718B price range would miss.

12- to 16-bit ADC Resolution

One product potentially addresses your measurement needs, from low to high resolution, as a function of sampling rate.

Auto Re-Trigger

When using Triggered Storage, triggers can automatically reset, creating a new file with pre and post trigger data each time the trigger level is breached.

Expandable with ChannelStretch*

Expand time-aligned channel count by adding as many as sixteen DI-4718Bs, DI-4108s, DI-4208s, and/or DI-1120s to one PC. Synchronously acquire from as many as 128 analog and 112 digital channels.

Comprehensive Programming Support

The DI-4718B includes a comprehensive .Net class for the Windows programming environment. A device protocol is fully documented for use with operating systems other than Windows.

Optional Power over Ethernet (PoE)

The optional Power over Ethernet feature allows you to both communicate with and power the DI-4718B via the Ethernet connector, sparing the inconvenience and expense of running power to the unit.

Ready-to-run Software Support*

Provided with ready-to-run WinDaq software for point-and-click DAQ performance with a real-time display, disk-streaming recording, and playback and analysis.

* WinDaq/Unlock required per device to use ChannelStretch™ using WinDaq software. ChannelStretch™ is not available when using the device as a stand-alone data logger.

DI-4718B Dimensional Drawing

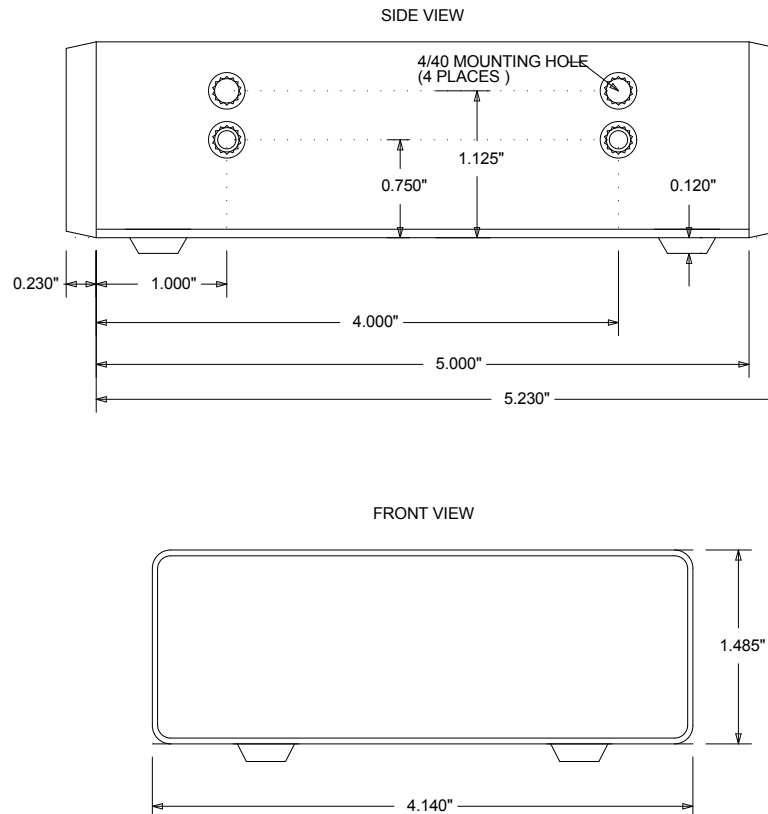

Anti-alias Filter Architecture

The DI-4718B employs an anti-alias filter per analog channel with automatic corner frequency selection. The filter is a CIC (cascaded integrator comb) type that uses as many as 512 samples per channel to calculate in real time as data is acquired. Filter response is optimized when sampling frequency is set to ten times the highest frequency of interest.

Typical Anti-alias Filter Frequency Response

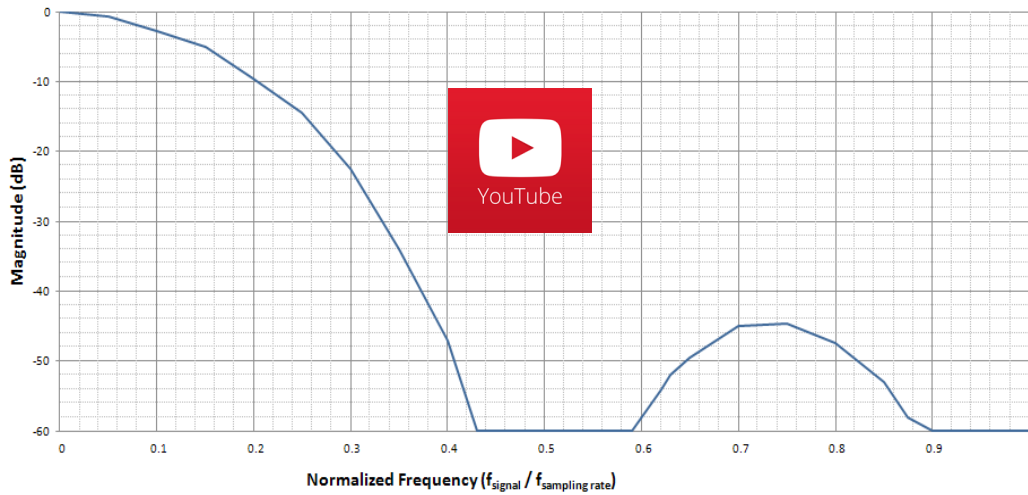

DI-4718B Scan List Flexibility

The DI-4718B maintains an internal scan list of as many as nine different items at once: eight analog channels and one digital input channel. The scan list can be populated with a combination of analog input channels and the digital input port. Maximum throughput of items in the scan list is 160 kHz for analog channels, increasing to 180 kHz with the digital channel enabled.

Item	Scan List Positions	Comments
Analog channels	Up to eight	One scan list position is consumed for each enabled analog channel. The scan entry defines the physical channel number and the full scale range of the measurement.
Digital inputs	One	Both digital ports are read simultaneously with one entry in the scan list.

Analog-to-digital Converter Characteristics

DI-4718B ADC resolution is a function of sampling rate: Slower sampling rates yield higher resolution measurements. The DI-4718B achieves this using its real time CIC decimation filter to improve signal-to-noise ratio and to increase measurement resolution. Before the DI-4718B such techniques were reserved only for high-end instrumentation because of the cost of processing power required to provide meaningful, multi-channel results in real time. But that cost has been driven down dramatically so that the 120 MIPS processor embedded in the DI-4718B is both affordable and more than adequate for the task.

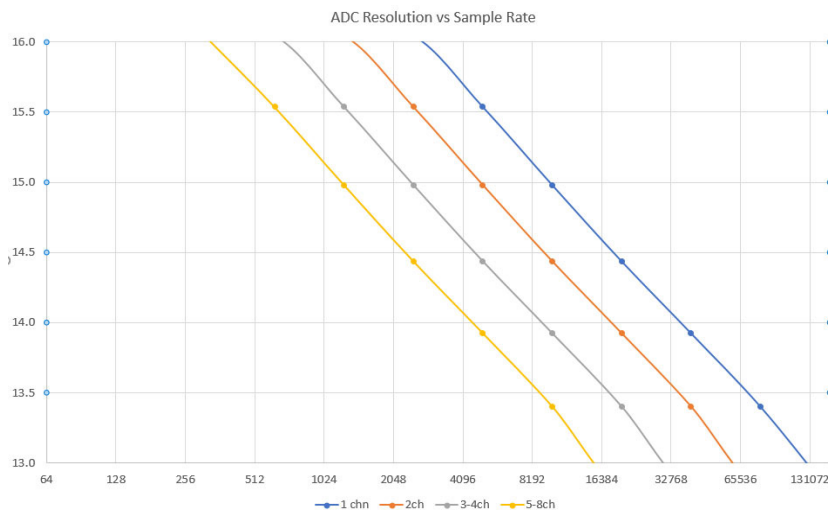

ADC resolution (R) is a function of selected sample rate per channel (F), and the number of enabled analog channels (C):

$$R = \frac{\log\left(\frac{160000}{FC}\right)}{\log(4)} + 12$$

Where:

C	Enabled Channels
1	1
2	2
4	3-4
8	5-8

USB Synchronization

Add up to fifteen additional DI-4718B, DI-1120, DI-4108, and DI-4208 USB instruments for a total of 128 analog channels and 105 digital ports at a maximum throughput rate ≥ 480 kHz using ChannelStretch™ technology (see Specifications section for details). Multiple instruments connected to the same USB hub synchronize to within 10 μ s between units. Cascade multiple USB hubs to accommodate up to 16 total devices. Best of all, when using WinDaq software, the enabled channels of all synced devices record data to the same WinDaq application. All data is displayed and stored together as if they were a single instrument. The WinDaq/Unlock option per device is required to synchronize when using WinDaq software.

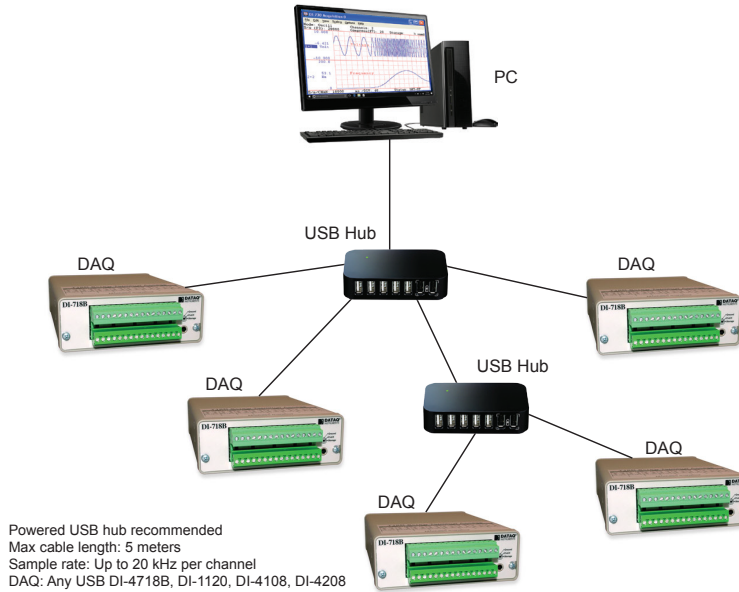

Ethernet Synchronization

Add up to fifteen additional DI-4718B instruments for a total of 128 analog channels and 105 digital ports at a maximum throughput rate ≥ 50 kHz using ChannelStretch™ technology (see Specifications section for details). Access the devices via LAN or WiFi. Multiple instruments connected to the same Ethernet switch automatically synchronize to within 200 μ s between units. Best of all, when using WinDaq software, data from the enabled channels of all synced units record data to the same WinDaq application. All data is displayed and stored together as though they were a single instrument. The WinDaq/Unlock option is required on a per-unit basis in order to synchronize using WinDaq software. The optional Power over Ethernet (PoE) feature powers the DI-4718BB. This saves time and money by eliminating the cost and inconvenience of running power to the device.

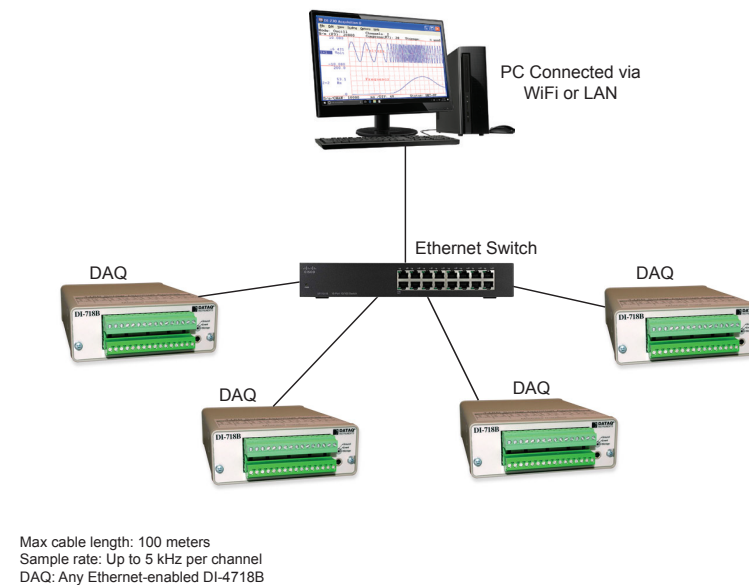

Stand-alone Data Logger Operation

A USB drive can be used to record and store up to 32GB of data. The DI-4718B can record continuously using a circular buffer (with pre-defined trigger conditions) or record-until-full approach. A push button allows manual start/stop control over the recording process. A multi-color LED shows the status of the DI-4718B (Record, Standby, Busy, Error).

Varying degrees of flash memory technology will influence performance when recording in stand-alone mode. With a flash memory card incorporating SLC technology, throughput rates up to 160 kHz can be achieved. That rate drops to 50 kHz when using a pSLC card, and 10 kHz using a flash memory card incorporating MLC or some other branded technology.

Flash Technology	Speed
MLC/Generic	Up to 20 kHz
pSLC	Up to 50 kHz
SLC	>50 kHz

Triggering with Stand-alone Operation

Set a trigger and the amount of pre and post trigger data scans to capture only the data you want.

With a trigger and number pre/post trigger scans selected, you can capture just the data you're interested in, before and after an event occurs. Choose a trigger level on any analog channel and acquire up to 2 G of pre and post trigger data to a USB drive. You can choose a trigger channel, trigger level and the number of pre and post trigger scans. The auto rearm option enables you to continuously create new files each time the threshold level is breached.

This is particularly useful in the case of a destructive test. For example, when ramping up current to a motor until a failure occurs, you're likely interested in how the motor behaved just prior to the failure, and what happened immediately thereafter. Was the failure gradual, or sudden? Were there indicators leading up to the failure? Triggered storage allows you to hone in on that information.

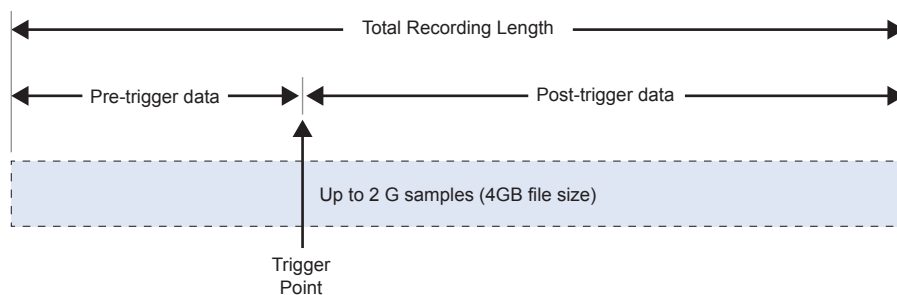

Specify the trigger channel, level, rising or falling slope.

Rising Slope

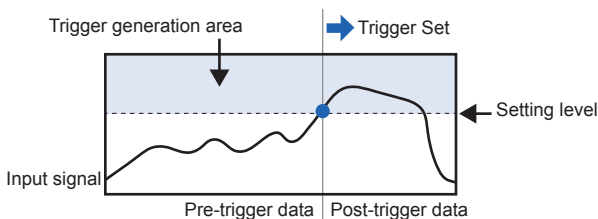

Falling Slope

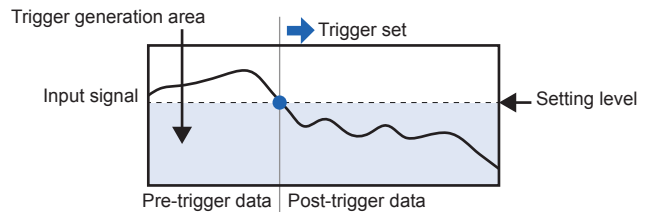

Stand-alone Setup

The stand-alone configuration for both USB and Ethernet versions of the DI-4718B is performed using the WinDaq Dashboard. With the DI-4718B plugged into an available USB port or accessible Ethernet port, run the WinDaq Dashboard, select the device you would like to configure, and select “Stand Alone Setup” from the “Configure” menu. Configurable settings include:

- Enable analog channel and setup - including selection of DI-8B module for automated scaling and range, reporting mode (average, last point, max, min), and user annotation.
- Enable digital channel for remote storage and events or general-purpose discrete inputs.
- File Storage mode including record on trigger conditions.
- Sample Rate selection as sampling interval.
- File Storage Format: WinDaq or CSV.
- Record on Power Startup option.
- Immediate Start Recording button for Ethernet-connected devices.
- Save Configuration and Load Configuration utility.

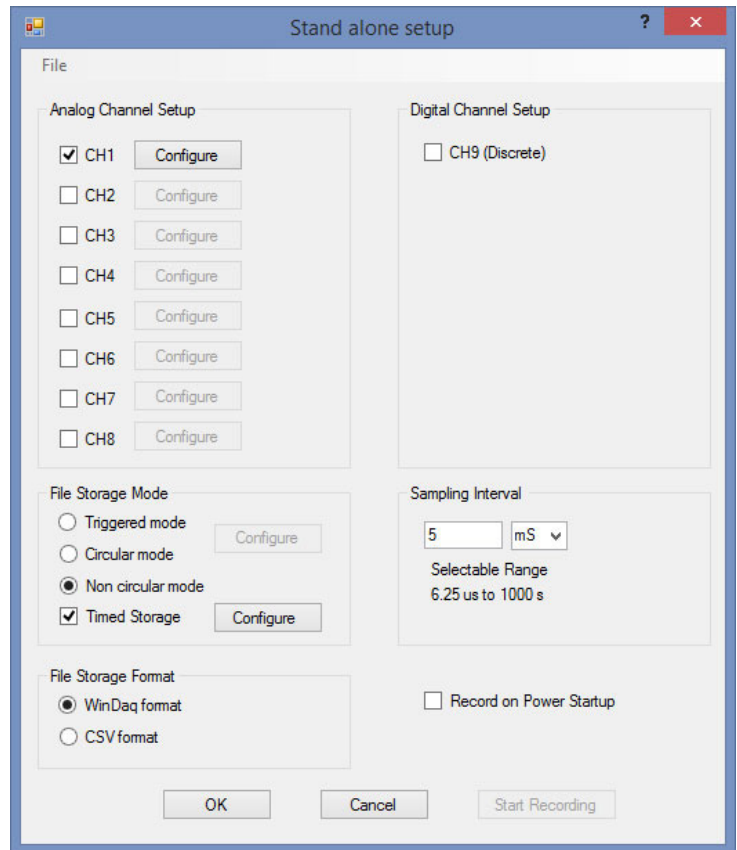

Ethernet Settings

The network configuration (assigning an IP address, subnet mask, etc.) can be performed from the WinDaq Dashboard. This provides easier setup on any Local Area Network. Connect the DI-4718B device via the USB port, set the IP address of the device, and then deploy the device on your network.

Alternatively, a JSON file (the JSON file must be named network.json) can be used to load the network configuration. The JSON file can be created using any text or JSON editor, and then placed on a USB flash drive.

With the DI-4718B in Stand-alone/Ethernet mode, press down and hold the control button while inserting the USB drive. This will force the device to retrieve any available configuration files from the drive.

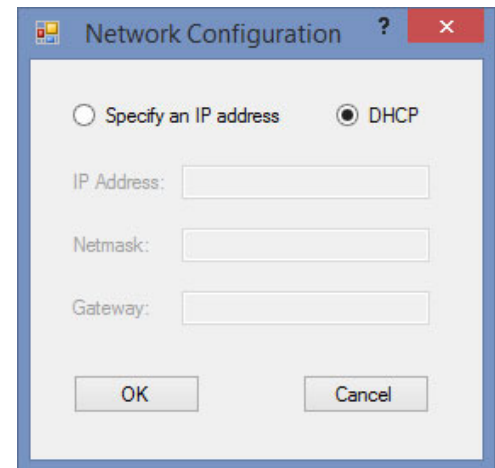

```
{
  "Network": {
    "IP": "192.168.0.196",
    "Netmask": "255.255.255.0",
    "Gateway": "192.168.0.1"
  }
}
```

What you can measure

Both low and high-level signal acquisition for industrial monitoring and recording in maintenance and troubleshooting, as well as quality control applications to measure:

- Programmable logic controller (PLC) parameters.
- Voltage measurements in the range of millivolts to 10 volts.
- 4-20 mA process current loops.
- Transducer outputs at either millivolt or high levels for:
 - Force;
 - Temperature;
 - Pressure/vacuum;
 - Torque;
 - RPM/Speed;
 - Load;
 - Strain;
 - Distance;
 - Many more.

Where you can measure

Design qualification and maintenance and troubleshooting applications where various mechanical and/or electrical parameters as described above are to be measured. These include such applications as:

- In-vehicle automotive testing.
- Remote wireless radio monitoring for signal strength, power supply voltages, etc.
- Agricultural equipment testing.
- Electromechanical timing and amplitude measurements on presses and mills (paper, steel, tube).

Tethered to a PC...

Use a PC-tethered DI-4718B anywhere it can remain connected to a laptop or desktop PC for long or short-term measurements. The USB option requires the PC to be local within 5 meters (15 feet). The Ethernet option allows the PC to be used locally or remotely (up to 100 meters without hubs). Because PC-tethered versions must communicate constantly with the host without latencies, dedicated networks are recommended for PC-tethered Ethernet versions.

...or Stand-alone

DI-4718B Stand-alone models can be used in all the same applications as PC-tethered versions, except data may also be stored locally to removable SD memory without a PC. Units with a USB interface upload data to a PC through the removal of the SD memory card to a reader. Remote uploading of stored SD memory data can be achieved using the Ethernet interface from anywhere on a LAN, WAN, or the Internet. Stand-alone features are designed for those who:

- Cannot locate a PC near the instrument for fear of theft or damage.
- Want easy and efficient access to remotely recorded information over their Ethernet LAN without leaving the comfort and security of their office.
- Want to record 24/7/365 as an aid to either process maintenance and troubleshooting, quality control, or design qualification without the added complexity and instability of a dedicated PC running Windows.
- Want remote, Ethernet- accessible data without the time and cost burden required to install a dedicated network.

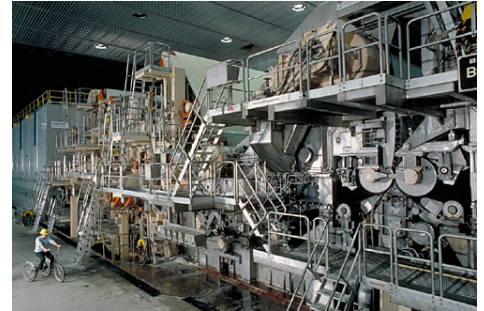

DI-8B Signal Conditioning Module Applications

AC or DC Current Shunt:

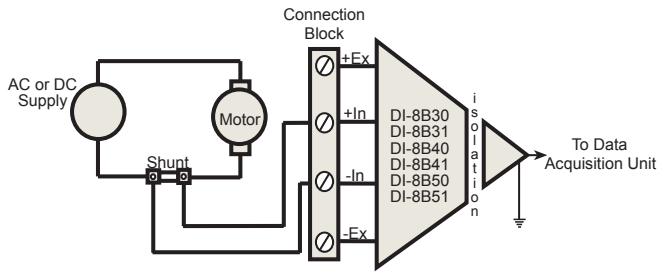

Frequency:

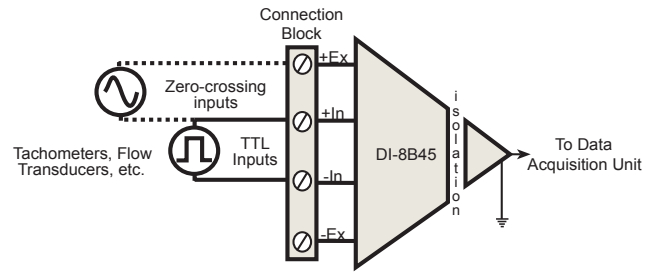

Process Current:

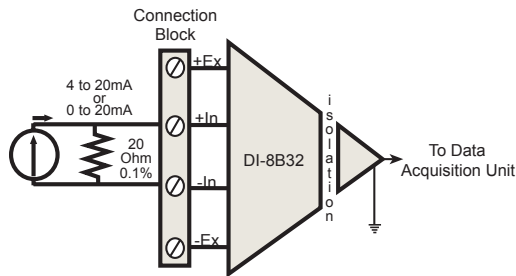

Full-Bridge Strain Gage:

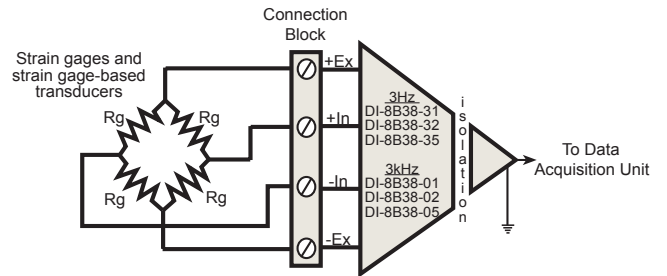

True RMS:

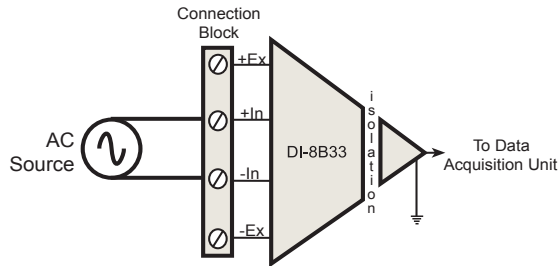

DC Transducer:

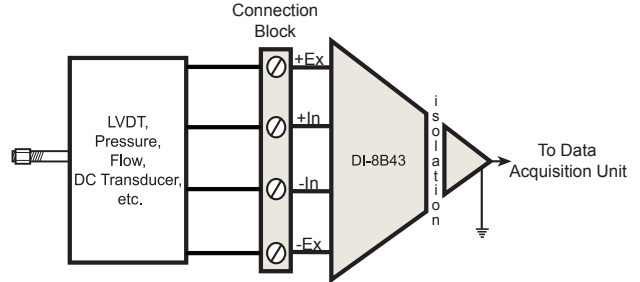

Floating Grounded TC:

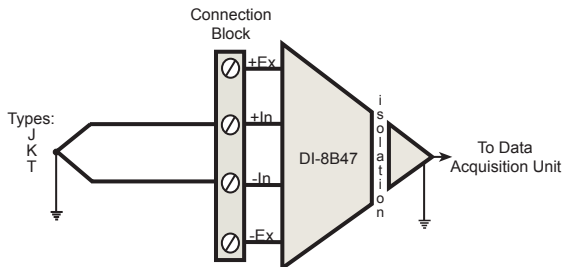

RTD:

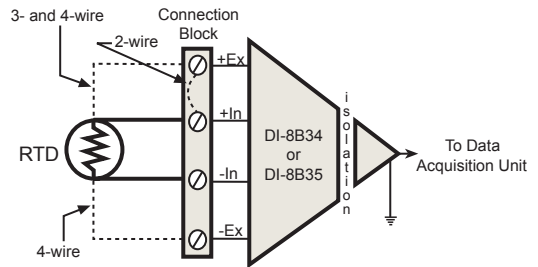

DI-8B Signal Conditioning Module Selection Guide

Each DI-8B module is a single channel, isolated analog input designed for a specific measurement. The modules filter, isolate, amplify, and convert input signals to a high-level analog signal suitable for A/D conversion. Over 75 modules address the full spectrum of industrial measurements.

Key Features

- Convenient, flexible, mix-and-match approach.
- Full isolation reduces noise and protects you and your equipment from large, common mode voltages.
- Small size 1.105" × 1.65" × 0.40".

Common Specifications

- 1000V Input-to-Output Isolation.
- 500V Channel-to-Channel Isolation.
- 240 VAC input protection.
- 160db common mode rejection.

Voltage Input Modules (3Hz BW)	
MODEL NO.	Input Range
DI-8B30-01	±10mV
DI-8B30-02	±50mV
DI-8B30-03	±100mV
DI-8B31-01	±1V
DI-8B31-02	±5V
DI-8B31-03	±10V
DI-8B31-07	±20V
DI-8B31-09	±40V
DI-8B31-12	±60V

Linearized 4-wire RTD Modules (1kHz BW)		
MODEL NO.	Type	Input Range
DI-8B35-01	100Ω Pt	-100°C to +100°C (-148°F to +212°F)
DI-8B35-02	100Ω Pt	0°C to +100°C (+32°F to +212°F)
DI-8B35-03	100Ω Pt	0°C to +200°C (+32°F to +392°F)
DI-8B35-04	100Ω Pt	0°C to +600°C (+32°F to +1112°F)

Frequency Input Modules (3Hz BW)	
MODEL NO.	Input Range
DI-8B45-01	0 to 500Hz
DI-8B45-02	0 to 1kHz
DI-8B45-03	0 to 3kHz
DI-8B45-04	0 to 5kHz
DI-8B45-05	0 to 10kHz
DI-8B45-06	0 to 25kHz
DI-8B45-07	0 to 50kHz
DI-8B45-08	0 to 100kHz

Current Input Modules (3Hz BW)	
MODEL NO.	Input Range
DI-8B32-01	4 to 20mA
DI-8B32-02	0 to 20mA

Voltage Input Modules (1kHz BW)	
MODEL NO.	Input Range
DI-8B40-01	±10mV
DI-8B40-02	±50mV
DI-8B40-03	±100mV
DI-8B41-01	±1V
DI-8B41-02	±5V
DI-8B41-03	±10V
DI-8B41-07	±20V
DI-8B41-09	±40V
DI-8B41-12	±60V

Linearized Thermocouple Input Modules (3Hz BW)		
MODEL NO.	Type	Input Range
DI-8B47J-01	J	0°C to +760°C (+32°F to +1400°F)
DI-8B47J-02	J	-100°C to +300°C (-148°F to +572°F)
DI-8B47J-03	J	0°C to +500°C (+32°F to +932°F)
DI-8B47J-12	J	-100°C to +760°C (-148°F to +1400°F)
DI-8B47K-04	K	0°C to +1000°C (+32°F to +1832°F)
DI-8B47K-05	K	0°C to +500°C (+32°F to +932°F)
DI-8B47K-13	K	-100°C to +1350°C (-148°F to +2462°F)
DI-8B47K-14	K	0°C to +1200°C (+32°F to +2192°F)
DI-8B47T-06	T	-100°C to +400°C (-148°F to +752°F)
DI-8B47T-07	T	0°C to +200°C (+32°F to +392°F)

Isolated True RMS Input Modules	
MODEL NO.	Input Range
DI-8B33-01	0mV to 100mV
DI-8B33-02	0V to 1V
DI-8B33-03	0V to 10V
DI-8B33-04	0V to 150V
DI-8B33-05	0V to 300V

Current Input Modules (100Hz BW)	
MODEL NO.	Input Range
DI-8B42-01	4 to 20mA
DI-8B42-02	4 to 20mA

Linearized 2- or 3-wire RTD Modules (3Hz BW)		
MODEL NO.	Type	Input Range
DI-8B34-01	100Ω Pt	-100°C to +100°C (-148°F to +212°F)
DI-8B34-02	100Ω Pt	0°C to +100°C (+32°F to +212°F)
DI-8B34-03	100Ω Pt	0°C to +200°C (+32°F to +392°F)
DI-8B34-04	100Ω Pt	0°C to +600°C (+32°F to +1112°F)

DC LVDT Input Modules (1kHz BW)	
MODEL NO.	Input Range
DI-8B43-01	-1V to +1V
DI-8B43-02	-2V to +2V
DI-8B43-03	-3V to +3V
DI-8B43-04	-4V to +4V
DI-8B43-05	-5V to +5V
DI-8B43-11	-1V to +1V
DI-8B43-12	-2V to +2V
DI-8B43-13	-3V to +3V
DI-8B43-14	-4V to +4V
DI-8B43-15	-5V to +5V

Potentiometer Input Modules (3Hz BW)	
MODEL NO.	Input Range
DI-8B36-01	0 to 100Ω
DI-8B36-02	0 to 500Ω
DI-8B36-03	0 to 1kΩ
DI-8B36-04	0 to 10kΩ

Voltage Input Modules (20kHz BW)	
MODEL NO.	Input Range
DI-8B50-01	±20mV
DI-8B50-02	±50mV
DI-8B50-03	±100mV
DI-8B51-01	±1V
DI-8B51-02	±5V
DI-8B51-03	±10V
DI-8B51-07	±20V
DI-8B51-09	±40V
DI-8B51-12	±60V

Strain Gage Input Modules			
MODEL NO.	Type	Bandwidth	Input Range
DI-8B38-01	Full	3kHz	±10mV, 3mV/V 100 to 10k
DI-8B38-02	Full	3kHz	±30mV, 3mV/V 300 to 10k
DI-8B38-05	Full	3kHz	±20mV, 2mV/V 300 to 10k
DI-8B38-31	Full	3Hz	±10mV, 3mV/V 100 to 10k
DI-8B38-32	Full	3Hz	±30mV, 3mV/V 300 to 10k
DI-8B38-35	Full	3Hz	±20mV, 2mV/V 300 to 10k

Remote Control Close-up

The DI-4718B supports several methods to increase measurement flexibility and data record interpretation. The remote record feature allows you to synchronize WinDaq recordings to external processes by remotely enabling and disabling WinDaq's stream-to-disk feature. Remote events allow you to insert an event marker in the data stream to identify when an event occurred relative to recorded waveform activity. Events can be activated by the pushbutton on the rear panel of the DI-4718B, with a keyboard keystroke (which also allows you to record a description), or remotely via the remote event input. The stream-to-disk function can also be controlled through the keyboard, or through the remote record input. Valid remote record and event signals are switch closures, or discrete levels with a maximum input of 25 V. Finally, each port is internally pulled-up, so it's easy to use with external dry-contact switches.

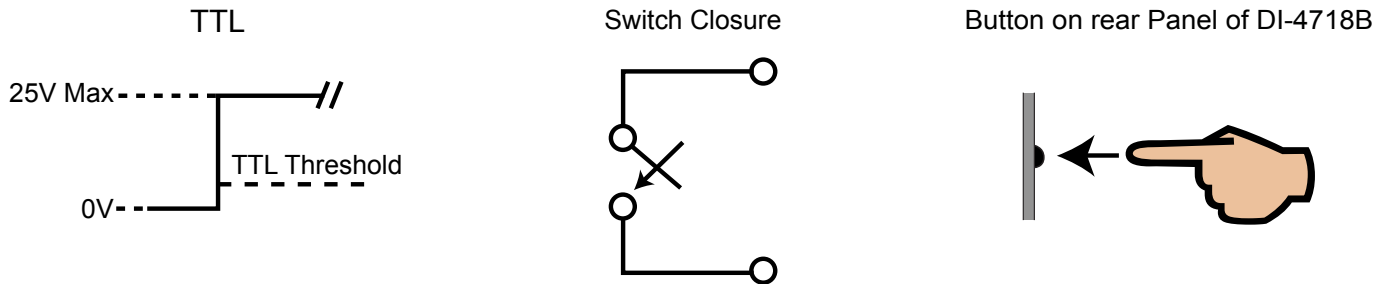

The built-in remote control jack located on the front panel of the DI-4718B accepts a standard 3.5mm stereo phone plug (provided) and provides access to remote events and stop/start remote recording control features. The Remote Control Feature can be used in Stand-alone mode or when using WinDaq Acquisition software.

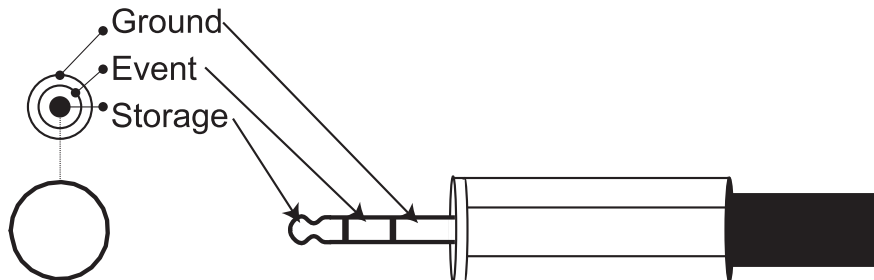

Four Analog Channel Reporting Modes

The DI-4718B can be configured per channel to report just the last sample acquired like other data acquisition products. Unlike other products, three additional reporting modes, selectable per analog channel, provide much more flexibility when reporting oversampled data.

Anti-alias filter

Oversampled data is passed through the DI-4718B's anti-alias CIC filter. Use this mode to dramatically reduce the unwanted effects of alias frequencies and noise.

Maximum value

Oversampled data is evaluated for the maximum value. Use Maximum to peak-detect complex waveforms.

Minimum value

Oversampled data is evaluated for the minimum value. Use Minimum to valley-detect complex waveforms.

All four operating modes are supported by WinDaq software. And, since they are applied by DI-4718B firmware, custom programs can easily leverage these features without incremental programming overhead.

Setup*

Double-click and enter the channels you want to acquire into the WinDAQ scan list, even from multiple units with Channel-Stretch™. Click to select signal averaging, maximum, minimum, or last point operation per channel. Click to define a single to 8-channel display - either triggered sweep (oscilloscope-like) or scrolling (chart recorder-like). Click again to define a sample rate ranging from two samples per hour to 160 kHz throughput per device.

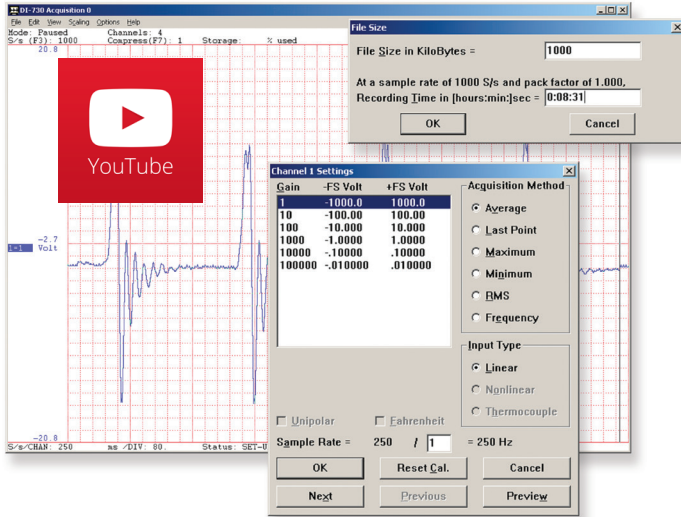

Calibrate

Define calibration per channel to display waveform values in meaningful units such as psi, °F or °C, amps, rpm, watts, horsepower — any unit of measure you need.

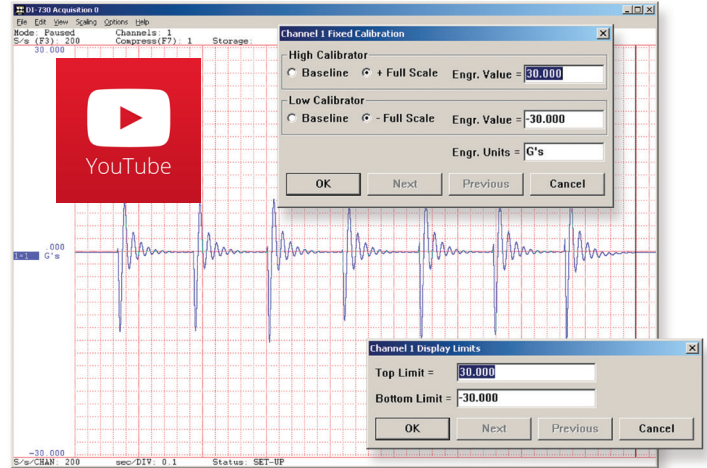

Record

Choose a continuous waveform recording mode or the triggered mode with selectable trigger level, slope, and post-trigger times. WINDAQ automatically time- and date-stamps, then streams acquired data to disk — record as much data as you need. At the same time, WINDAQ supplies a real-time graphical display of any or all channels so you always know where you are and where you're going.

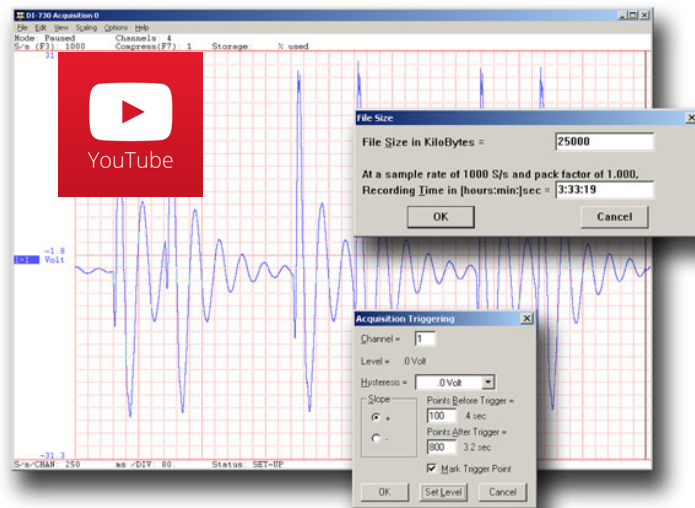

Annotate

Of course, you can label any channel with text that describes it — “Motor 1,” “Engine speed,” “Vertical position,” etc. But WINDAQ also allows you to supply commented event markers while you record — “Beginning test phase 1,” “Small vibrations noticed,” “Starting cool-down cycle,” etc. Your comments and our acquired data combine to form a complete diary of your data acquisition session.

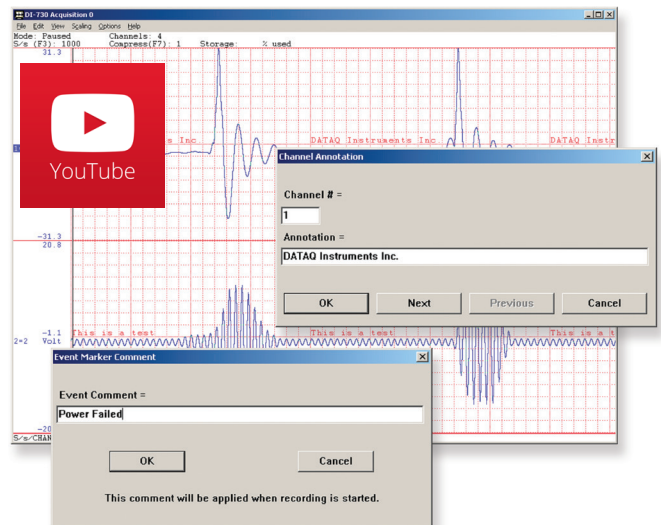

* WinDAQ/Unlock required per device to use ChannelStretch™ and to record more than four total channels when using WinDAQ software.

Playback

Recording is only half the solution. WINDAQ's Waveform Browser playback software allows you to graphically manipulate waveforms in ways you've never seen on a PC. Compress an entire recording to one screen-width for a bird's eye view, then expand around an area of interest for a closer look. Use the cursor to measure amplitudes and timing with precision. Move to any event marker with the click of a mouse button.

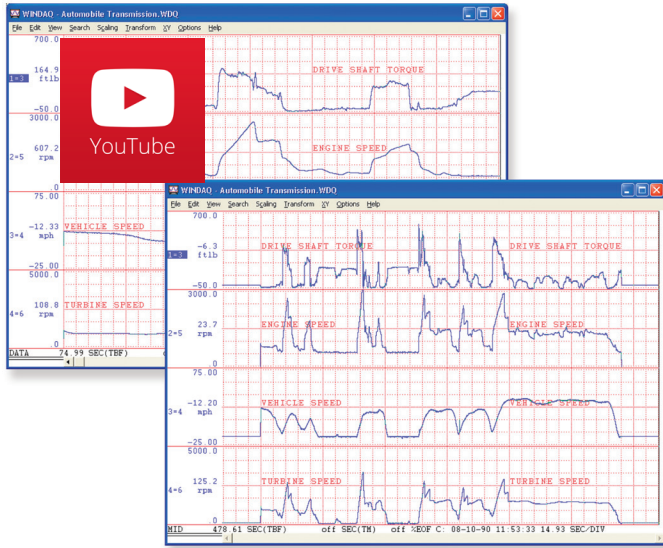

Multitask

Double your productivity and let WINDAQ record while you review last week's results from your spreadsheet, or compose a memo with your word processor. You can even play back data already stored to disk while you're still recording.

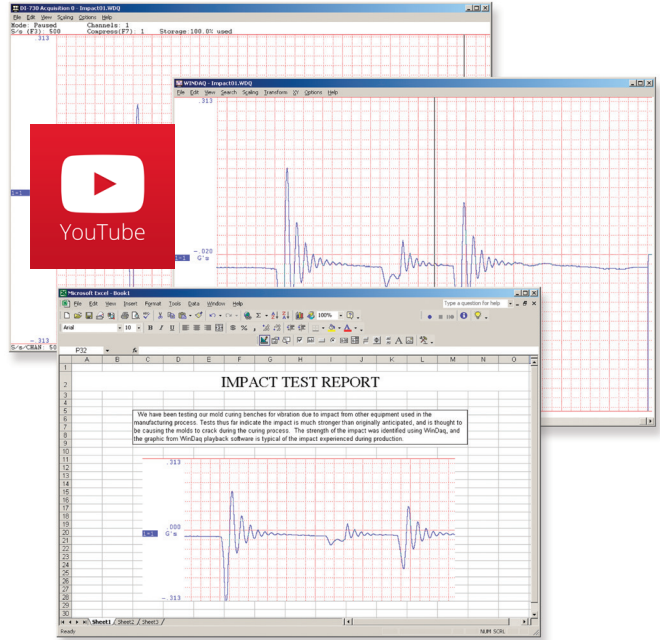

Analyze

Waveform interpretation is easy with our built-in analysis functions. Apply frequency and filtering analysis with the WINDAQ Waveform Browser FFT and DFT functions. Analyze any range of waveform data with the statistics function. Use X-Y plotting to examine the relationship of one channel to another. Optional Advanced CODAS analysis functions allow waveform peak detection, integration, differentiation, arithmetic operations, and more.

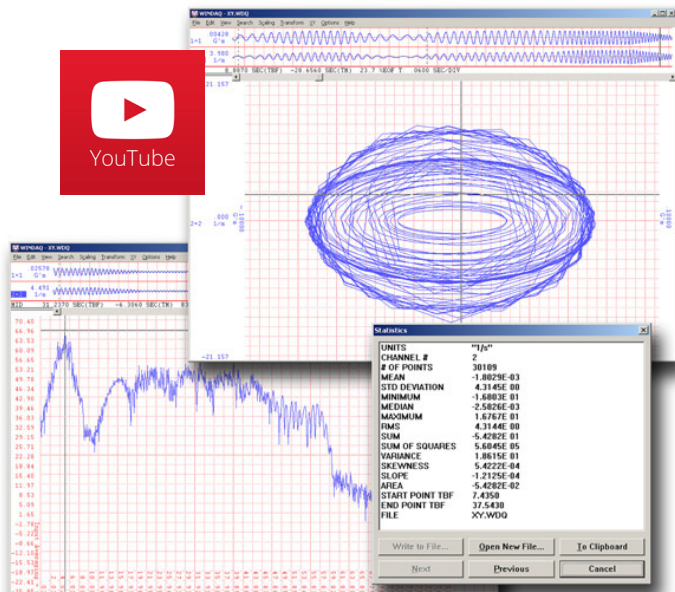

Export

The WINDAQ Waveform Browser can export any range of data to your spreadsheet, or any other analysis or presentation package you use. You can even copy a graphical image displayed by the WINDAQ Waveform Browser and paste it directly into a word processing document. Finally, export any range of waveform graphics to your printer for a hard copy record.

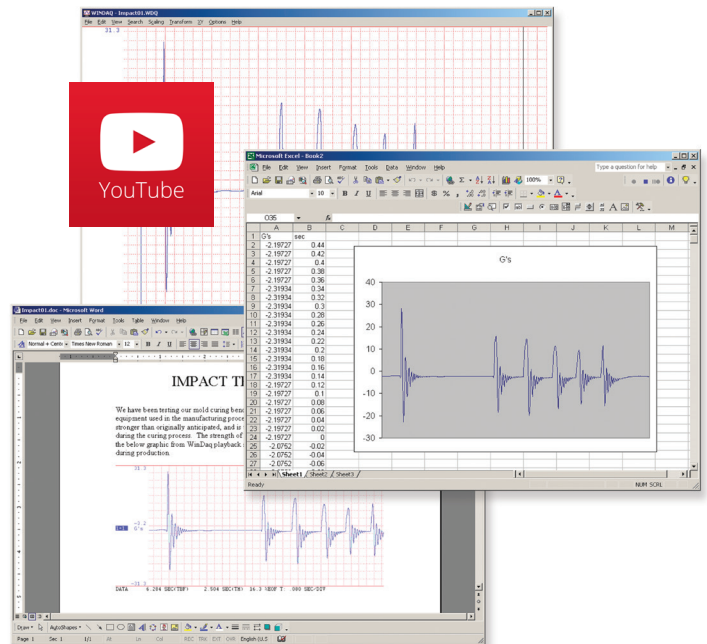

Published Protocol and .Net Class

Sometimes you can't use a ready-to-run application like WinDaq. You need to develop your own software to perform in precisely the way you need. That requirement defines the need for programming support so you have the tools necessary to move forward.

Included .NET Class

Microsoft's object-oriented programming languages commonly referred to as .NET ("Dot Net") offer a powerful environment for developing custom applications for the DI-4718B. All of the .NET languages are supported by our included class library, which supports all DI-4718B features. Well-commented example programs exercise every aspect of the hardware, forming a foundation for you to get your own applications up and running quickly and painlessly. Currently the .NET class only supports the USB DI-4718Bs.

Included DI-4718B Protocol Documentation

As you probably suspect when you run our point-and-click WinDaq data acquisition software, there's a lot going on beneath the surface. WinDaq software needs to take the data acquisition configuration that you design using its menu system and communicate that to the hardware. These are things such as sample rate, the number of channels enabled, the specific channel numbers enabled, etc. Diving down to the lowest level of program activity, past the WinDaq user interface, beyond the device driver to the actual commands sent to the data acquisition hardware and the format of the responses they evoke, is the protocol. The protocol defines the exact set of commands a program can send to the hardware, and how the hardware will react as a result. So, if you know the command and response definitions for the DI-4718B (i.e., its protocol), the instrument can be folded into virtually any operating system and any programming language: Python, C++, Linux, Windows, OSX, etc.

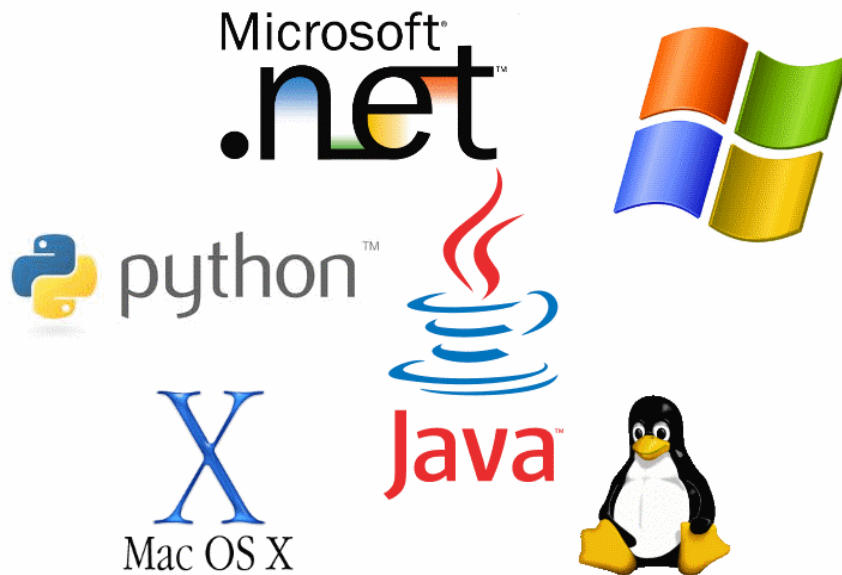

DI-4718B Specifications

Analog Inputs

Number of Channels:	8 configured for signal conditioned inputs
Channel Configuration:	Defined by DI-8B Module
Measurement Range:	Defined by DI-8B Module
Accuracy:	±0.25% FSR (at 1800 S/s, averaging mode)
Input Impedance:	Defined by DI-8B Module
Input offset voltage:	Defined by DI-8B Module
Channel-to-channel crosstalk rejection:	-75db @ 100Ω unbalance
Offset temperature coefficient:	0.25µV/°C
Digital filtering:	Standard: Conditional over-sampling Stand-alone: None
CJC Error:	1.5°C plus 8B Module

Isolation (via DI-8B Modules)

Input-to-Output:	1000VDC/Peak AC
Channel-to-Channel:	500VDC/Peak AC

Digital Inputs

Ports:	2
Resolution:	MOSFET switch
Threshold Levels:	TTL-compatible
Max applied Voltage:	25 V DC

Digital Ports

Ports:	2
Maximum drain voltage:	25 V
Maximum sink current:	100 mA
Reserved Digital Inputs:	D0: WinDaq Remote Events D1: WinDaq Remote Start/Stop

A/D Characteristics

Type:	Successive approximation
Resolution:	12 to 16-bit
Conversion Time:	69.4µs

Scanning Characteristics

Max. throughput sample rate:	Standard: 160 kHz Stand-alone: 20 kHz to 160 kHz*
Min. throughput sample rate:	Standard: 20 Hz (2.2 samples per hour with WinDaq) Stand-alone: 0.0017 Hz
Sample Rate Timing Accuracy:	100 ppm
Max. scan list size:	9 entries
Sample buffer size:	2kb

*Dependent on SD card used.

Calibration

Calibration cycle:	One year
---------------------------	----------

Ethernet Interface

Type:	10/100Base-T
Connector:	RJ-45
Protocol:	TCP/IP
Server Type:	DHCP or Fixed IP

Removable Memory

Type:	MLC, pSLC, or SLC flash memory (with USB SD card reader); USB thumb drive
Required Format:	FAT32

Indicators, Connections, and Controls

Rear Panel

Button:	Multi-function control
USB A Connector:	USB drive for stand-alone data logging
Ground Lug:	Terminal for ground
Status LED:	Single multi-color LED

	Connecting	Idle	Armed	Recording	Rearmed	Busy	Error
USB	○●	●●	—	●●	—	—	●●
Ethernet	○●	●●	—	●●	—	—	●●
Drive	○●	●●	●●	●●	●●	●●	●●

Power Connector:	USB: 9 to 36 VDC, 2 watts + 8B modules Ethernet: 9 to 36 VDC, 2.5 watts + 8B modules
-------------------------	---

Ethernet Connector:	RJ45; Optional PoE
----------------------------	--------------------

Front Panel

Input connectors:	Two, removable sixteen position terminal blocks, 28 AWG min, 16 AWG max
Radio Jack:	Standard 3.5 mm for remote control signals

ChannelStretch™ Operation

USB

Total Max Units:	16
Max Channel Count:	128 Analog, 112 Digital
Max Throughput:	≥480 kHz
Synchronization Conditions:	Syncs with any combination of DI-1120, DI-4108, and DI-4208 USB instruments. All synced instruments must operate at the same sample rate per channel, regardless of channel number, type, or range. All instruments must be connected to the same USB controller. The use of USB hubs are recommended to meet this requirement.

Ethernet

Total Max Units:	16
Max Channel Count:	128 Analog, 112 Digital
Max Throughput:	≥50 kHz
Synchronization Conditions:	Syncs with other Ethernet DI-4718Bs. For most accurate synchronization, all instruments should be connected to the same Ethernet switch.

Power

Power Consumption:	1.5W + 8B Modules
---------------------------	-------------------

Environmental

Operating Temperature:	0°C to 50°C
Operating Humidity:	0 to 90% RH non-condensing
Storage Temperature:	-20°C to 60°C
Storage Humidity:	0 to 90% RH non-condensing

Physical Characteristics

Enclosure:	Aluminum base with steel wrap-around.
Mounting:	Desktop; Bulkhead
Dimensions:	5 ⁷ / ₁₆ "D × 4 ¹ / ₈ "W × 1 ¹ / ₂ "H (13.81D × 10.48W × 3.81H cm.)
Weight:	14 oz.
Power Requirements:	USB: 9 to 36 VDC, 2 watts + 8B modules Ethernet: 9 to 36 VDC, 2.5 watts + 8B modules

Software Support

WinDaq software:	View Supported Operating Systems at https://www.dataq.com/products/windaq/windows-compatibility/
Programming:	DATAQ .NET Class, Instrument protocol, ActiveX Control

Ordering Information

Description	Order No.
DI-4718 USB Data Acquisition (DAQ) System Portable USB data logger featuring eight DI-8B module inputs and stand-alone data logger capability. DI-8B modules sold separately.	DI-4718B-U
DI-4718 Ethernet Data Acquisition (DAQ) System Portable Ethernet data logger featuring eight DI-8B module inputs and stand-alone data logger capability. DI-8B modules sold separately.	DI-4718B-E
DI-4718 PoE Data Acquisition (DAQ) System Portable Ethernet data logger featuring eight DI-8B module inputs and stand-alone data logger capability. DI-8B modules sold separately.	DI-4718B-E-P
MLC Flash Memory Card Low-speed micro SD flash memory card. Recommended for recording rates under 20 kHz throughput.	2000351
16GB pSLC Flash Memory Card High-speed micro SD flash memory card. Recommended for recording rates from 20 kHz throughput to 50kHz.	101014-16-MS
32GB pSLC Flash Memory Card High-speed micro SD flash memory card. Recommended for recording rates from 20 kHz throughput to 50kHz.	101014-32-MS
4GB SLC Flash Memory Card High-speed micro SD flash memory card. Recommended for recording rates over 50 kHz throughput.	101014-4-HS
8GB SLC Flash Memory Card High-speed micro SD flash memory card. Recommended for recording rates over 50 kHz throughput.	101014-8-HS
Flash Card Reader Flash memory card reader for micro SD cards.	2000352
WinDaq Unlock Unlocks ChannelStretch™ to allow synchronized data acquisition and full stand-alone data logging capability where all channels can be recorded to the flash drive (without the Unlock Code only a single channel may be recorded to flash memory).	WinDaq/Unlock DI-4718B



DATAQ Instruments, Inc.
 241 Springside Drive
 Akron, Ohio 44333
 Phone: 330-668-1444
 Fax: 330-666-5434

Data Acquisition Product Links

(click on text to jump to page)

[Data Acquisition](#) | [Data Logger](#)